

# ABB eXplore Touchscreen



**Style conventions used in this document:**

**UI Text:** Text that represents elements of the UI such as button names, menu options etc. is presented with a grey background and border, in Tahoma font which is traditionally used in Windows UIs. For example:

Ok

**Standard Terms (Jargon):** Text that is not English Language but instead refers to industry standard concepts such as Strategy, BACnet, or Analog Input is represents in slightly condensed font. For example:

BACnet

**Code:** Text that represents File paths, Code snippets or text file configuration settings is presented in fixed-width font, with a grey background and border. For example:

```
$config_file = c:\CYLON\settings\config.txt
```

**Parameter values:** Text that represents values to be entered into UI fields or displayed in dialogs is represented in fixed-width font with a shaded background. For example

10°C

**Product Names:** Text that represents a product name is represented in bold colored text. For example

INTEGRA™

**Company Brand names:** Brands that are not product names are represented by bold slightly compressed text:

ABB Active Energy

**PC Keyboard keys:** Text representing an instruction to press a particular key on the keyboard is enclosed in square brackets and in bold font. For example:

[Ctrl]+[1]

<b>1</b>	<b>OVERVIEW</b>	
	<b>SiteGuide / Aspect with eExplore.....</b>	<b>4</b>
	SiteGuide .....	4
	ASPECT HTML5.....	4
	<b>eExplore in the ABB Cylon system .....</b>	<b>5</b>
<b>2</b>	<b>COMMISSIONING THE EXPLORE</b>	
	<b>Installing the eExplore unit .....</b>	<b>6</b>
	Dimensions .....	6
	Electrical Connections .....	7
	Mounting Options.....	7
	<b>Configuration procedure.....</b>	<b>11</b>
	1] Power up the eExplore unit.....	11
	2] Access the eExplore Configuration Application .....	11
	3] Configure Network Settings for the eExplore Device: .....	12
	4] Specify the Target Controller.....	15
	Advanced settings .....	16
<b>3</b>	<b>THE SITEGUIDE INTERFACE</b>	
	<b>Default Screen .....</b>	<b>17</b>
	<b>Menu Screen.....</b>	<b>18</b>
	<b>Standard Navigation Buttons.....</b>	<b>19</b>
	<b>Password Protection.....</b>	<b>20</b>
	<b>Point Items .....</b>	<b>21</b>
	Setpoints .....	21
	Hardware Points.....	22
	<b>Alarm Screen .....</b>	<b>23</b>
	<b>Datalog Screen .....</b>	<b>24</b>
	<b>Comms Controller Schedule .....</b>	<b>25</b>
	How to open a Schedule for editing.....	25
	How to view Standard or Exception times for the selected schedule .....	25
	How to edit one or more on/off time pairs .....	26
	<b>Date&amp;Time.....</b>	<b>27</b>
	<b>SiteGuide Menu Icons.....</b>	<b>28</b>
	Menu layout .....	28
	Generic Icons.....	29
	Preconfigured Icon list .....	30
<b>4</b>	<b>ASPECT® HTML INTERFACE</b>	

# 1 Overview

The Cylon eXplore is a standalone, easily customizable, menu-driven touchscreen front end for Cylon's Building Energy Management System (BEMS). eXplore is suitable for supervision of small sites where:

- a) no PC is available to run Supervisor software and
- b) a more attractive display than a text keypad is required.

eXplore has a color touchscreen and graphical presentation that is suitable for front-office end user applications.

It can be panel-mounted for local supervision (e.g. plant room), or can be wall mounted (e.g. front office, reception, boardroom etc.).

A key feature of the Cylon eXplore over Cylon's text keypads is its ability to display datalogs graphically.

User-friendly and attractive interfaces are provided for adjusting time schedules and setpoints.

## SITEGUIDE / ASPECT WITH eXplore

The eXplore touchscreen can be used with both the SiteGuide menu-driven interface or the ASPECT® interface.

### SITEGUIDE

The SiteGuide interface is based on a menu structure (created for each BMS Site by the System Integrator). This menu structure is very flexible, allowing the System Integrator to create building-specific interfaces that are intuitive to the end user. The menu structure is engineered using the CXpro<sup>HD</sup> Keypad Builder Interface for rapid development.

The menu structure is downloaded to the target CBXi-8R8(-H) IP Controller or UC32.netK Communications Controller by the CXpro<sup>HD</sup> Keypad Builder Interface (new version required). Once the SiteGuide application on the eXplore touchscreen is configured with that Controller as its target, it will automatically read the menu structure from the Controller and display it.

To configure the eXplore unit for use with the SiteGuide program in a CB or Unitron controller SiteGuide system, you must have a CBXi-8R8(-H) or UC32.netK Communications Controller with firmware that supports the SiteGuide V2.2 (i.e. version 2.03.01 or later).

To configure the eXplore unit for use as a SiteGuide, set the Target IP address (as described in in 4J Specify the Target Controller on page 15) to point at a CBXi-8R8(-H) or UC32.netK that hosts a SiteGuide program.

For information on using the SiteGuide UI, see 3 The SiteGuide Interface on page 17

### ASPECT HTML5

If eXplore is configured to target a Nexus Series or other ASPECT Control Engine (ACE) then it can display any page within the ACE's configured HTML5 UI. It is best to bear the touchscreen size in mind when designing an ASPECT UI for eXplore.

To configure the eXplore unit for use as an ASPECT® supervisor, set the Target IP address (as described in 4J Specify the Target Controller on page 15) to point at an ACE.

The ASPECT® HTML5 interface is generated by ASPECT®-Studio, for details on how to use the UI See Cylon Manual MAN0129 ASPECT-Studio help for full details.

# eXplore IN THE ABB CYLON SYSTEM

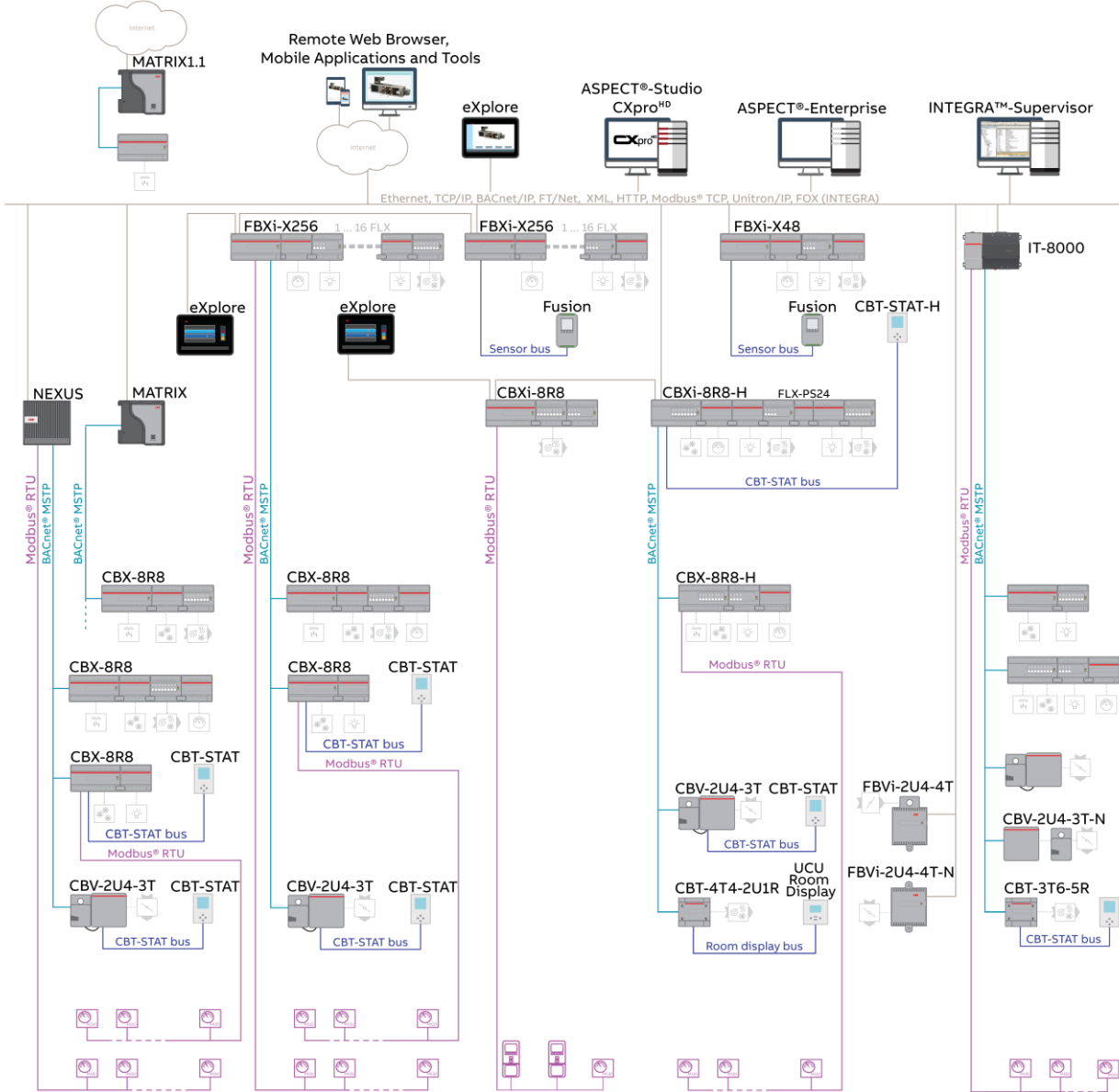

FBXi-X256 / CBXi-8R8 / CBX-8R8	FLX-8R8 -H	FBVi-2U4-4T	NEXUS Series	Fusion Smart Sensor
CBXi-8R8-H / CBX-8R8-H	FLX-4R4-H	FBVi-2U4-4T-N	MATRIX Series	CBT-STAT
CBV-2U4-3T	FLX-PS24	eXplore	INTEGRA Series	UCU Room Display
FLX-8R8 / FLX-4R4 / FLX-16DI	CBT-4T4-2U1R			



## ELECTRICAL CONNECTIONS

The eXplore device requires the following electrical connections:



**Note:** Network connection can be via WiFi instead of Ethernet if required

## MOUNTING OPTIONS

Panel Mounting

A Panel Mounting plate and 4 fixing screws are included as standard in the eXplore kit.

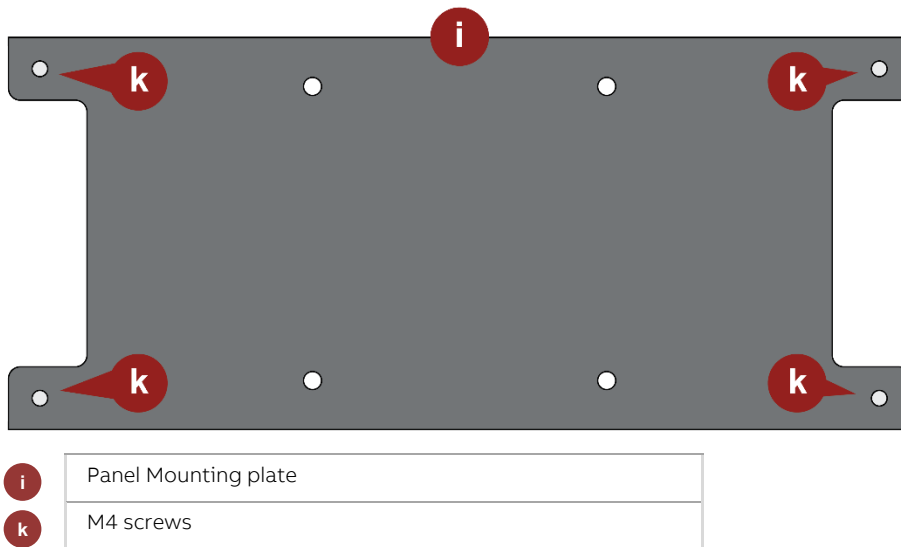

### Mounting procedure

Cut a rectangular hole 190 mm wide long by 115 mm high in the panel / cabinet door.

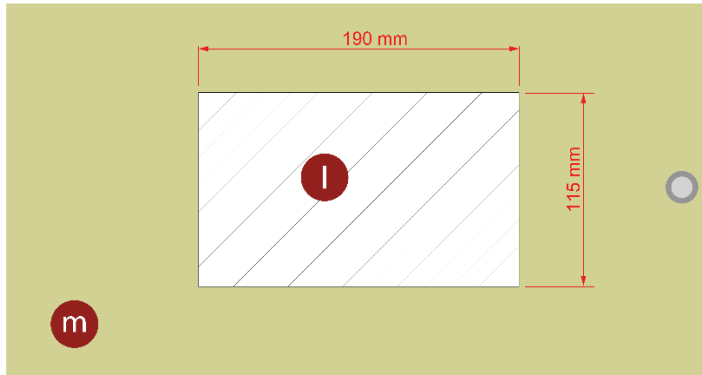

- l** Hole to be cut out
- m** Panel door

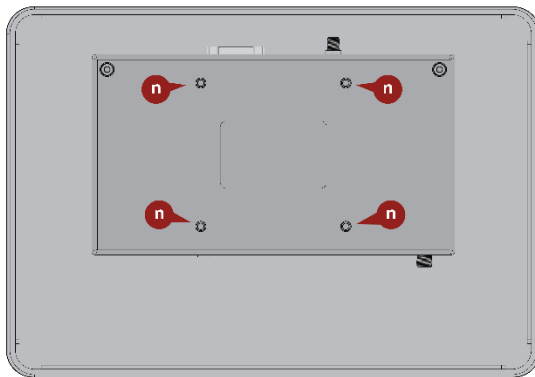

**eXplore-C10**

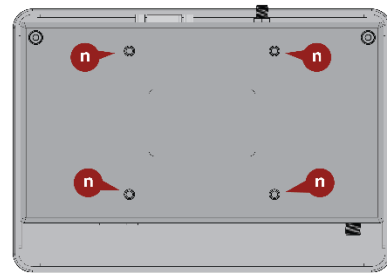

**eXplore-C7**

- n** 4 x VESA 75 screw holes (4 x M4 screws included in packaging)



Mount the eXplore device so that its front side is against the front of the panel door, and the body is passing through the hole cut in the door.

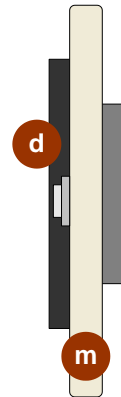
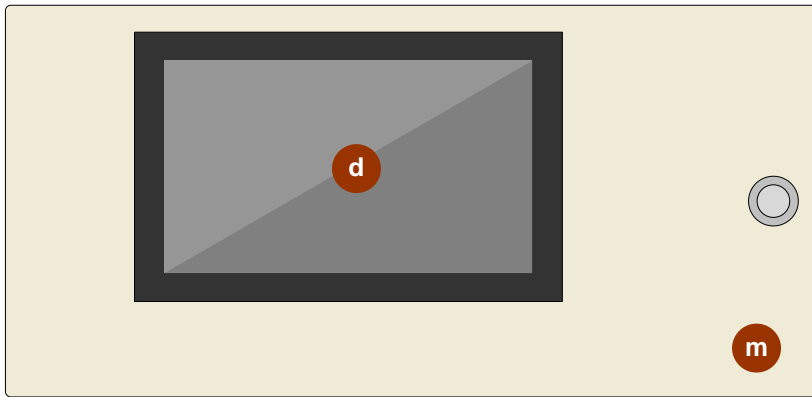

d	eXplore
m	Panel door

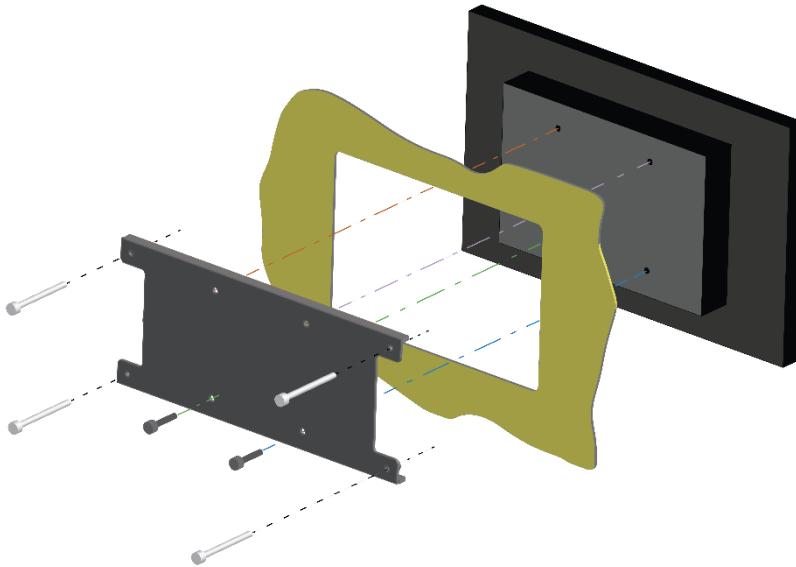

Place the back plate against the back of the eXplore unit and re-insert the 4 x VESA 75 screws.

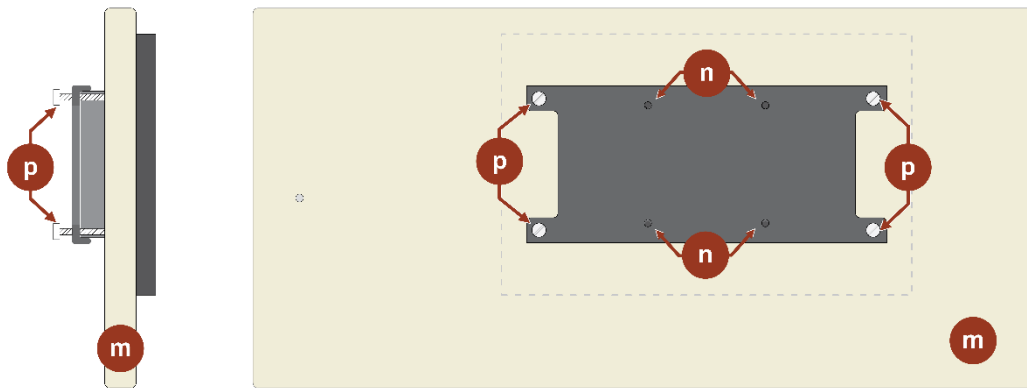

- n 4 x VESA 75 screws (included in packaging)
- p M4 mounting screws

Tighten the M4 mounting screws P on the bracket to apply appropriate pressure to secure the device against the panel door.

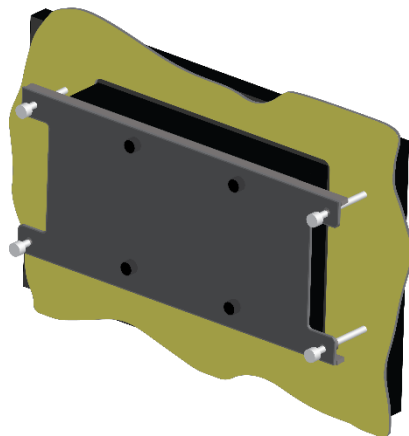

Wire up Power and Ethernet connections.

#### VESA wall mounting

The eXplore-C7 / eXplore-C10 housings are standard VESA 75 mm compliant.

VESA 75mm mounting brackets can be used for surface mounting (not supplied).

Only use the supplied 4 x screws for attaching a VESA 75 mm bracket

## CONFIGURATION PROCEDURE

To configure the eXplore unit for use as an ASPECT® supervisor, set the Target IP address (as described in in 4] Specify the Target Controller on page 15) to point at an ASPECT® Control Engine.

To configure the eXplore unit for use with the SiteGuide program in a CB or Unitron controller SiteGuide system, you must have a CBXi-8R8(-H) or UC32.netK Communications Controller.

### 1] POWER UP THE EXPLORE UNIT

Apply power to the eXplore device

- If the Target Controller has been configured with a Keypad Program, the after a minute or so the SiteGuide UI or ASPECT® UI (whichever is supported by the Target Controller) will be displayed.
- If the eXplore cannot connect to a Target Controller then an error will be displayed. You can resolve this by setting the Target – and eXplore’s own IP address - in the eXplore configuration application.

### 2] ACCESS THE EXPLORE CONFIGURATION APPLICATION

To enter the configuration application, swipe from the left of the screen,



and enter the security PIN. The factory default value for this PIN is 29566285 (“cylonct!”).



If the PIN is correctly entered, the eXplore app will display a “PIN Correct” message, and the main Settings menu.

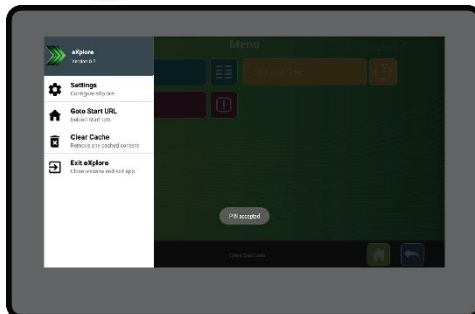

### 3] CONFIGURE NETWORK SETTINGS FOR THE EXPLORE DEVICE:

If necessary the IP address can be set as follows:

1. Select **Settings** from the main menu. This will open the **Settings** page:

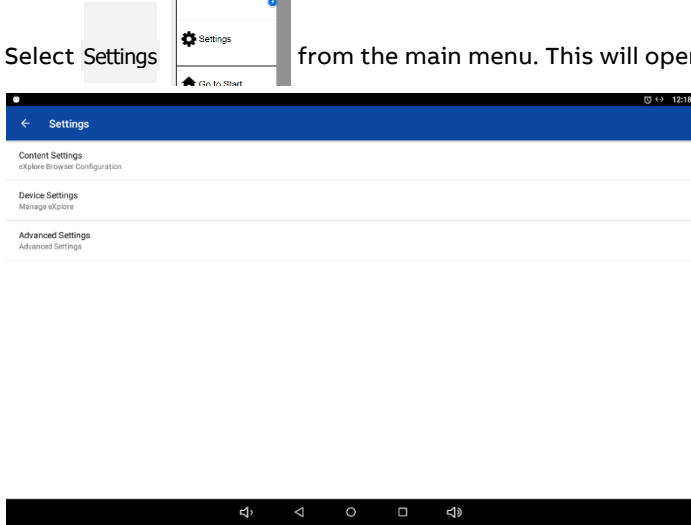

2. Select **Device Settings** from the menu to open the **Device Settings** Screen:

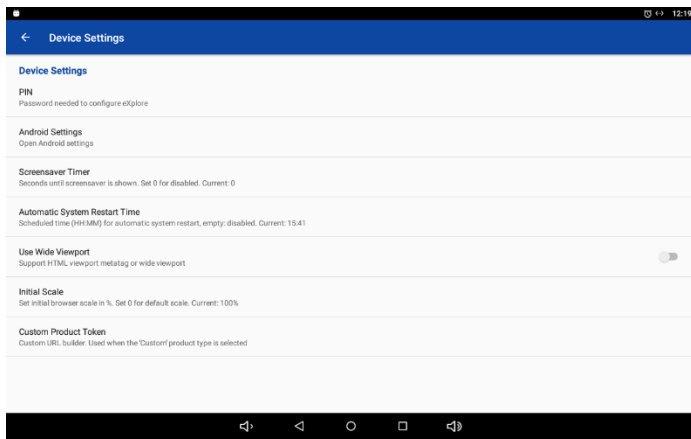

3. Select **Android Settings** to open the **Android Settings** screen.

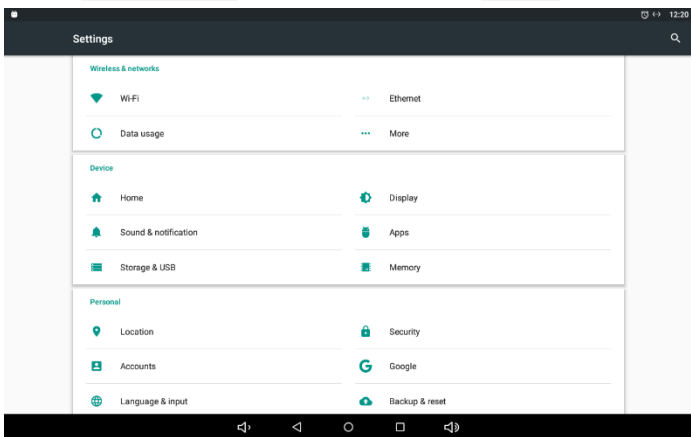

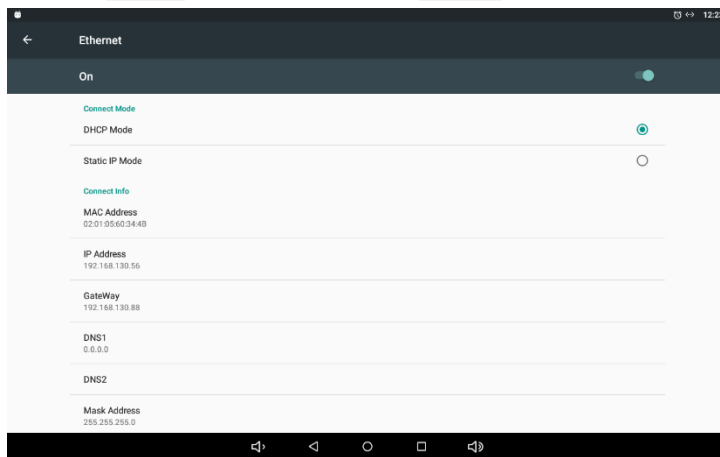

Wired Ethernet connection

4. If the eXplore unit is to be connected to the network by wired Ethernet, select Ethernet from the Android Settings page to display the Ethernet page:

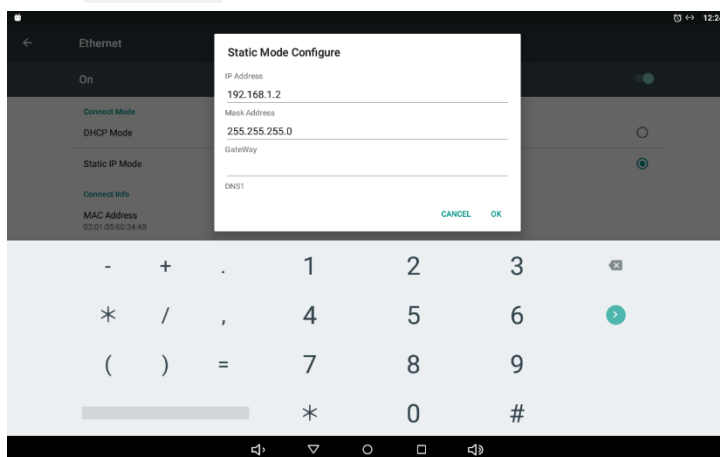

5. Select Static IP Mode



6. And set the IP Address and Mask, and the Gateway if required. Click OK to save.
7. Use the “back” button  at the bottom of the screen several times to return to the eXplore Configuration application (Settings Page).
8. Use the “back” button  at the bottom of the screen several times to return to the eXplore Configuration application (Settings Page).



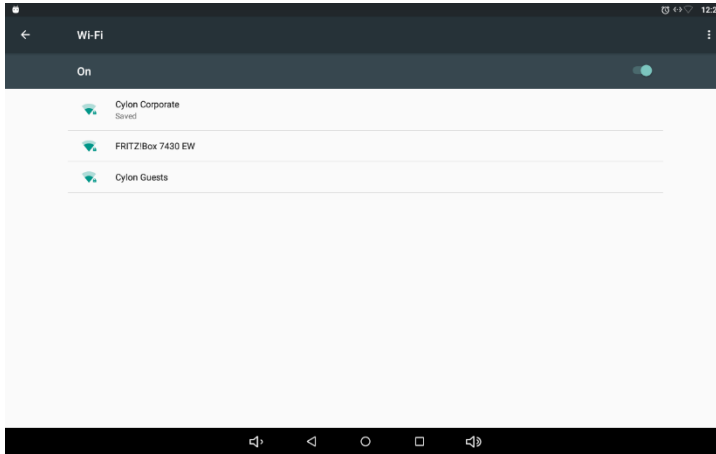

Wireless Ethernet (Wifi) connection

9. If the eXplore unit is to be connected to the network by wireless Ethernet, select **WiFi** from the Android Settings page to open the Wifi Page:

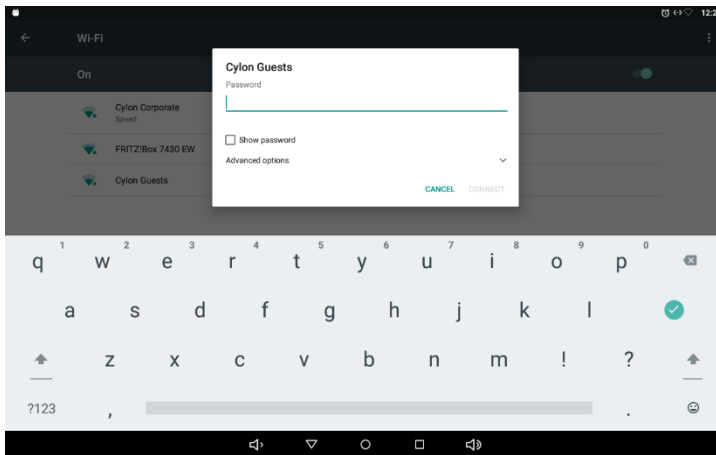

10. Select the network to which you wish to connect, and enter the relevant password:



11. Click **Connect** to connect to the wireless network
12. Use the “back” button  at the bottom of the screen several times to return to the eXplore Configuration application (Settings Page).

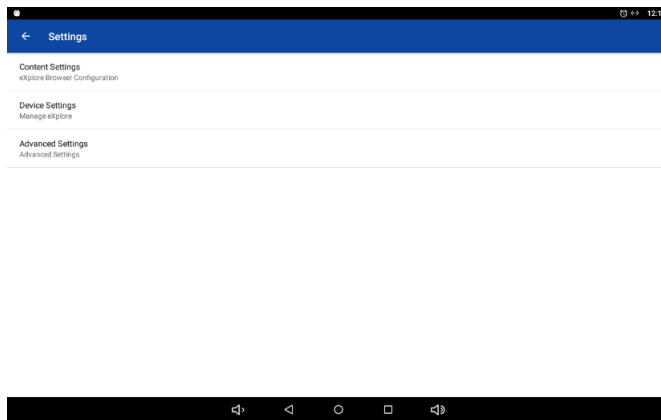

#### 4] SPECIFY THE TARGET CONTROLLER

1. Select **Settings** from the main menu. This will open the **Settings** page:



2. Select **Content Settings** to open the **Content Settings** page

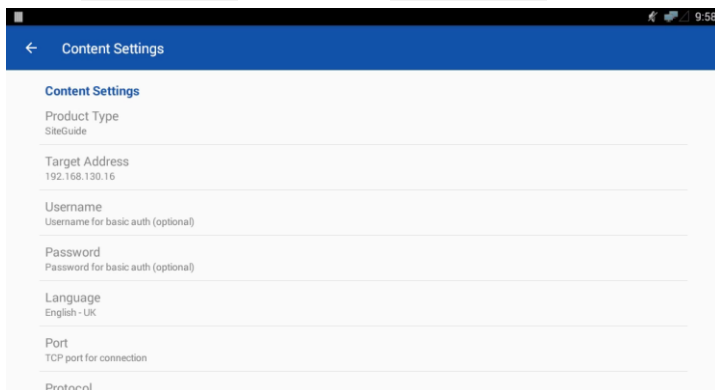

3. Select **Product type** and set either **SiteGuide** or **ASPECT** (defaults to **SiteGuide**).
4. Then select **Target Address**. This opens a dialog where you can enter the IP address of the Target Controller.

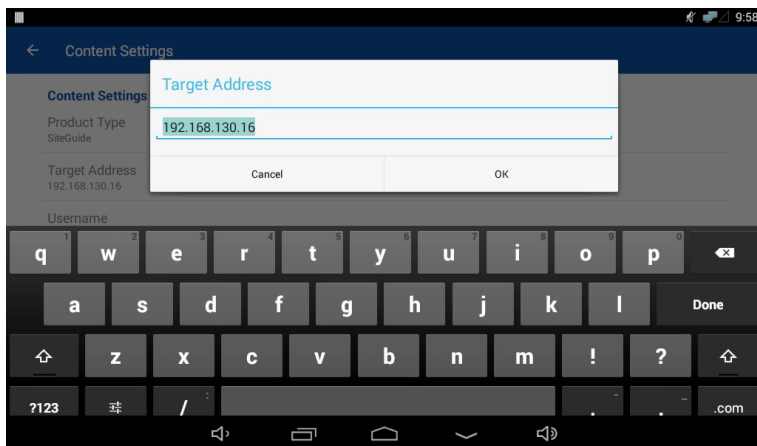

Click **OK** to return to the **Content Setting** page

5. Select **Port**, and set to the port used by the Target Controller e.g. **80** (**SiteGuide** default), or **7226** (**ASPECT®** default)

6. Set the **User Name** and **Password** for the Target Controller in the same way (defaults to SiteGuide values – *sg/sg*)

The screenshot shows a configuration form with two input fields. The first field is labeled 'Username' with a sub-label 'Username for basic auth (optional)'. The second field is labeled 'Password' with a sub-label 'Password for basic auth (optional)'. Both fields have a light gray border and a small 'x' icon in the top right corner for clearing the text.

**Note:** The language setting is used to localize inbuilt strings in the **SiteGuide** UI, but strings that are configured in the **CXpro<sup>HD</sup> Keypad Builder** and stored in the keypad file (“*.kpm1*” file) will be displayed as configured.

7. When finished, use the **back button**  at the top left of the screen to return to the eXplore configuration application.
8. Select **Go to Start URL** to open the configured UI in the target Controller.

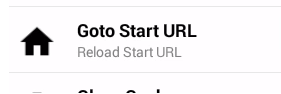

**Note:** For a **SiteGuide** host, this assumes that a keypad program has been downloaded to the **SiteGuide** host Controller from the **CXpro<sup>HD</sup> keypad builder**. If not, the **Go to Start** button will not open the UI.

**Note:**

For details on how to use the **ASPECT<sup>®</sup>** UI see *Cylon Manual MAN0129 ASPECT-Studio help*.  
 For information on using the **SiteGuide** UI, see *3 The SiteGuide Interface* on page 17.

## ADVANCED SETTINGS

If you contact Cylon TSG for a specific issue, you may be asked to access the **Advanced Settings** menu. Cylon TSG will be able to determine the PIN for this option on your **eXplore** device if required.



### 3 The SiteGuide Interface

The **SiteGuide** interface consists of a number of standard screens as described below, which display elements of a Cylon BMS Site as configured in the **CXpro<sup>HD</sup> Keypad Builder** interface. see Cylon manual *MAN0138US CXpro<sup>HD</sup> Keypad Builder* for details.

#### DEFAULT SCREEN

The Default Screen is the screen that is displayed while the **SiteGuide** menu structure is not being used. It displays up to 4 lines of text - either point values or arbitrary text strings.

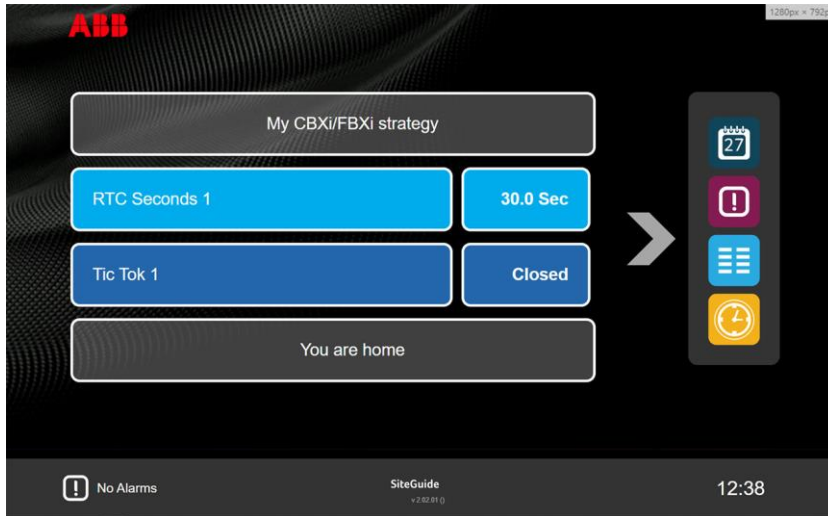

The current Controller time is displayed at the bottom right-hand corner of the Default screen. This is read from the Target UC32.netK.

In addition there is an alarm display area showing the most recently-triggered active alarm (if alarm list has been added to the menu in Keypad Builder)

If alarms are active then the most recent one is shown at the bottom of the Default Screen,

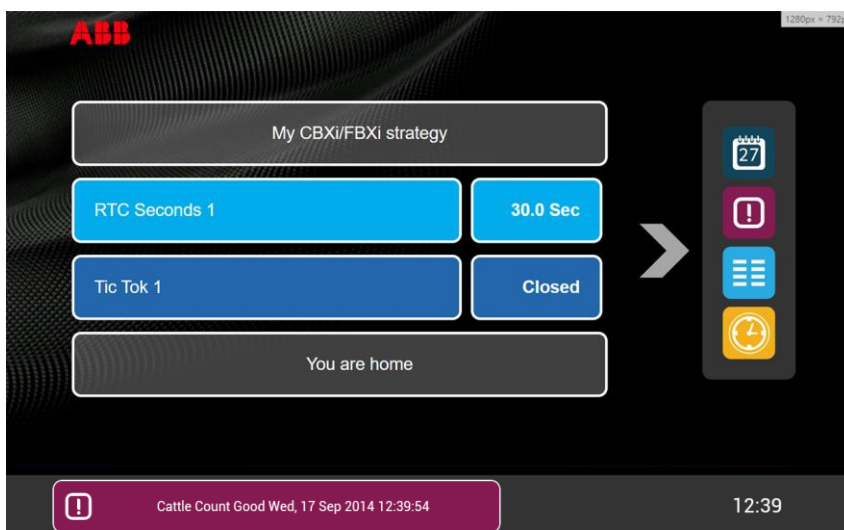

and touching this bar opens the **Alarms List** (see *Alarm Screen* on page 23). Touching anywhere else on the default screen opens the **Menu Screen** for the root menu defined in the **CXpro<sup>HD</sup> Keypad Builder**.

## MENU SCREEN

Menus defined in the Keypad builder are displayed in the **SiteGuide** as a 2-column list of text + icon

(  ) items:

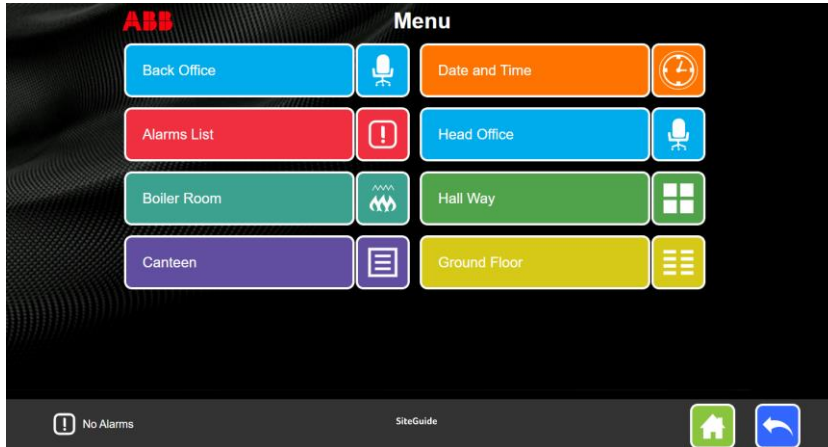

The icons are chosen depending on:

1. The type of item – Alarms, Date/Time and Schedule have fixed icons and colors
2. Keywords – if the menu description (defined in the Keypad builder) contains one of the terms in *Preconfigured Icon list* on page 30 then the associated icon will be displayed.
3. Position – If the menu item is not one of the recognized types, and does not contain a recognized term, then an icon will be assigned from the *Generic Icons* on page 29.

The color of each menu item is also assigned by position, unless it is one of the recognized types.

Touching on a **Menu Item** opens the associated menu or editor (in the case of recognized types).

**Menu items** that represent Points or Setpoints do not have an icon but instead display the point value. For setpoints and overridable hardware points, editing features are also displayed – see *Point Items* on page 21.

## STANDARD NAVIGATION BUTTONS

At the bottom of most SiteGuide screens, there are 3 standard buttons:

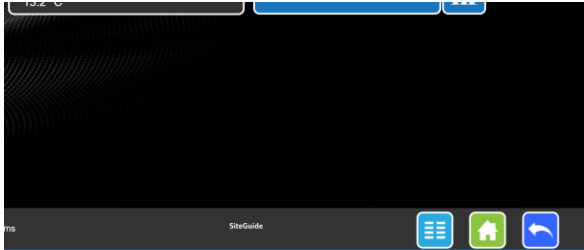

These buttons have the same purpose in all screens:



Menu



Home (default screen)



Back

## PASSWORD PROTECTION

Any menu can be protected by a password of between 4 and 6 characters, preventing access to sections of the menu structure by unauthorized users. This is configured in the CXpro<sup>HD</sup> Keypad builder – see *MAN-0138 CXpro<sup>HD</sup> Keypad Builder* for details.

When a user tries to open a password protected menu, they will be presented with a screen allowing them to enter a combination of arrow symbols. This is to allow compatibility with existing UCKRA420 keypads.

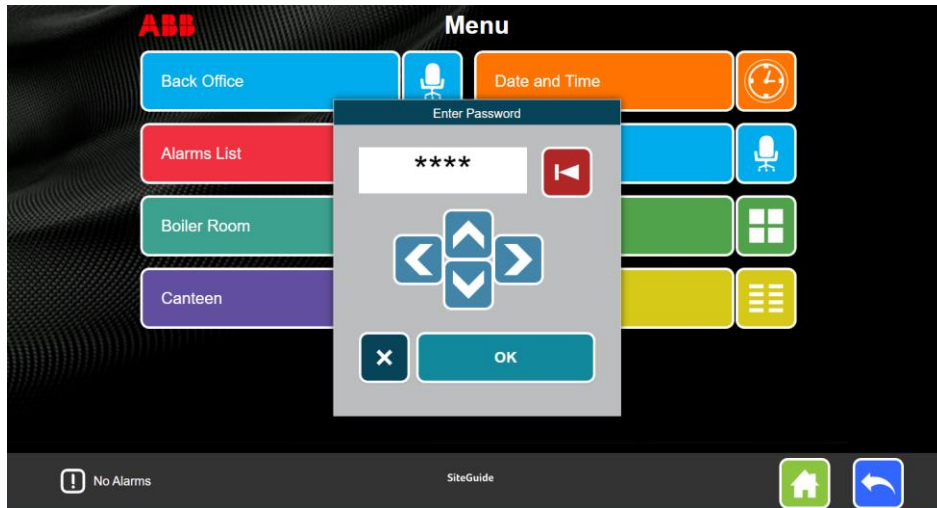

When the password is entered, press the OK button

- If the password is valid, the relevant menu will be displayed on the **SiteGuide** screen.
- If the password is invalid, then the password input changes color:

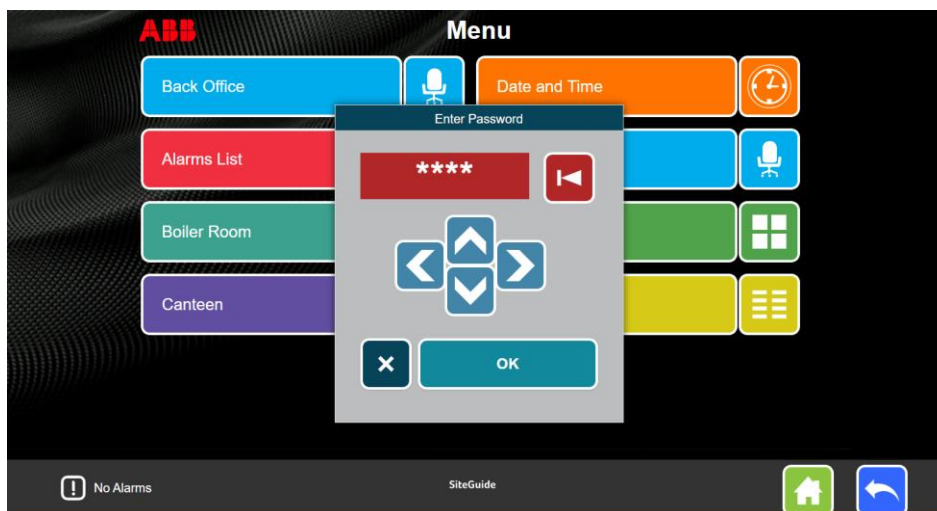

## POINT ITEMS

The value for each point will be displayed along with the point name in the **SiteGuide** menu as shown here:

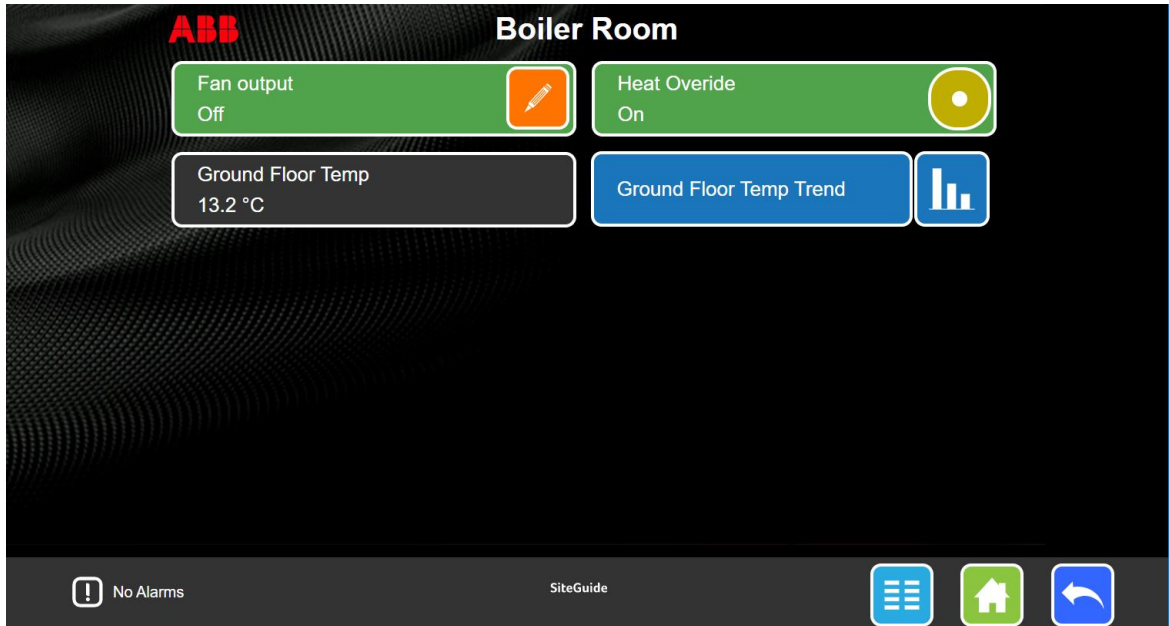

The **SiteGuide** menu allows the values of Setpoints to be adjusted directly, and Hardware points to be overridden (if configured to do so in the **EC Keypad Builder**):

## SETPOINTS

Analog Values

### Setpoints

**Analog** setpoint values are adjusted by using the increment/decrement buttons in the menu item



Digital Values

### Setpoints

**Digital** setpoint values are “toggled” by pressing the button in the menu item

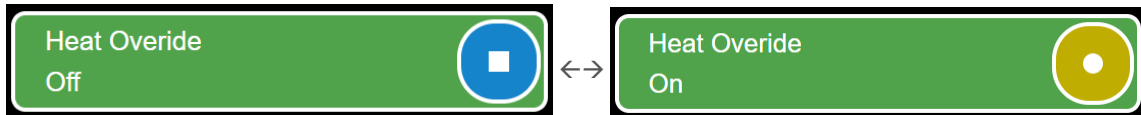

## HARDWARE POINTS

If override is not enabled for a hardware point, the value will be displayed but cannot be edited.



If override is enabled for a hardware point, an edit button will be displayed in its menu item, and an icon beside the value will indicate whether override is currently active or inactive:



Touching the edit button will open the **override editor**:

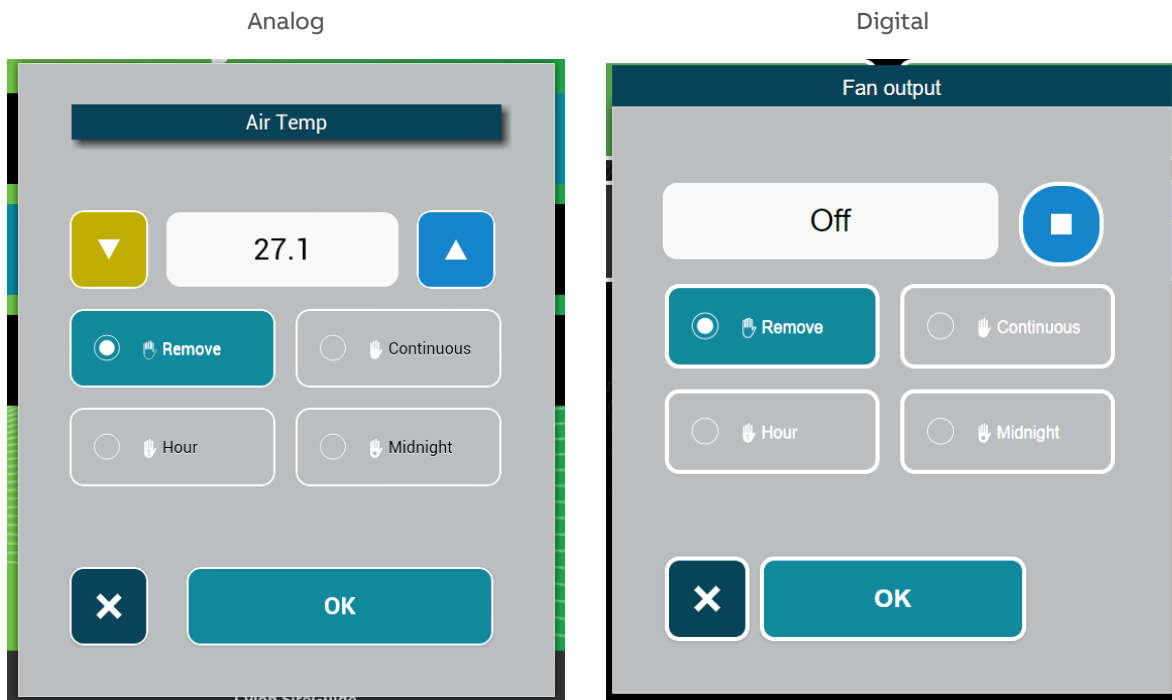

For Analog points, the override value can be set using the **value spinner**,

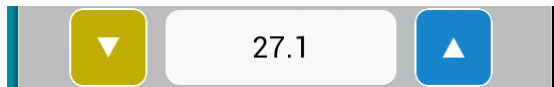

For Digital points the override value can be toggled by touching the **toggle button**,



The duration of the override must be specified by selecting one of the 4 buttons

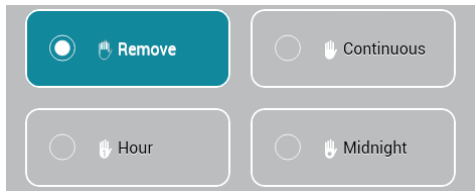

- **Remove** means that the override will not be applied, and the point value will be the value generated by the Strategy.
- **Continuous** means that the point value will remain at the specified override value indefinitely.
- **Hour** means that the point value will remain at the specified override value for a period of one hour, and then revert to the value generated by the Strategy.
- **Midnight** means that the point value will remain at the specified override value until the next midnight, when it will revert to the value generated by the Strategy.

## ALARM SCREEN

The Alarm Screen (opened from a menu item or from the alarm display on the Default Screen) lists the current contents of the Comms Controller Alarms List.

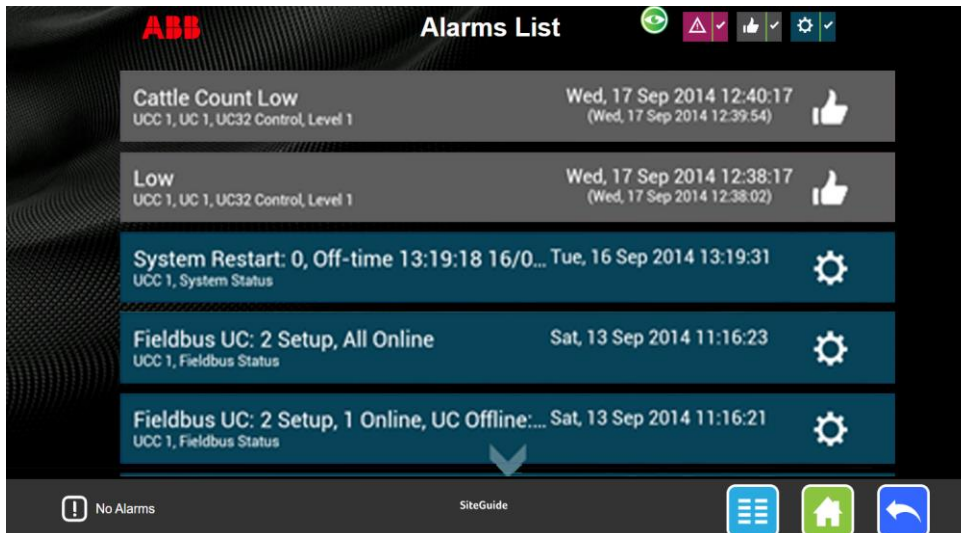

You can scroll through all of the items in the list by “dragging” the screen.

This display can be filtered to include any combination of Active Alarms, Inactive Alarms, or System Alarms by turning on or off the filter buttons on at the top of the screen.

If System Alarms are disabled in the keypad program, then System Alarms are not displayed in this list.

## DATALOG SCREEN

The SiteGuide will display a datalog as a graphical trace:

e.g. Analog Datalog:

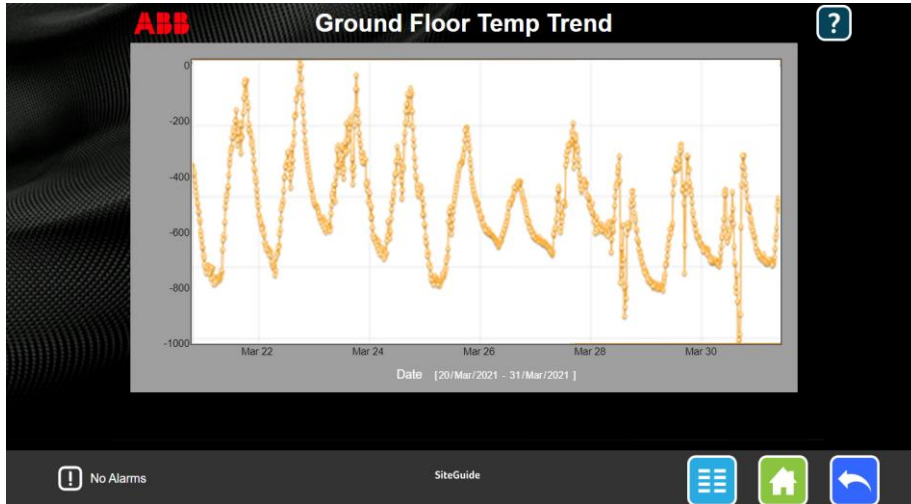

e.g. Digital datalog

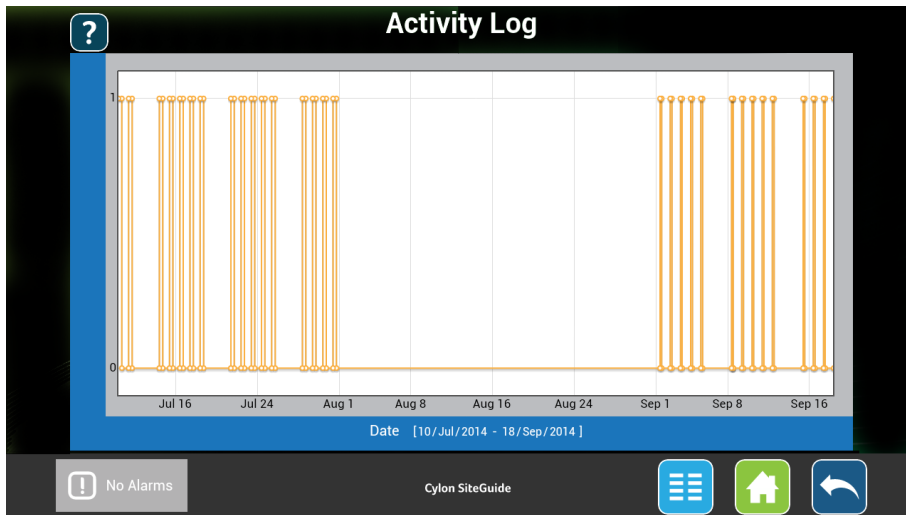

**Note:** Both triggered and interval-based time-stamped Datalogs are supported.



## COMMS CONTROLLER SCHEDULE

The Comms Controller Time Schedule screen (accessed from a menu item) shows the contents of the Comms Controller Schedule specified by the menu item.

A Comms Controller Time Schedule consists of the following elements:

1. **Exceptions:** Exceptions apply on a specific range of dates (e.g. holidays). Each weekday within an Exception can only have a single on/off time pair.

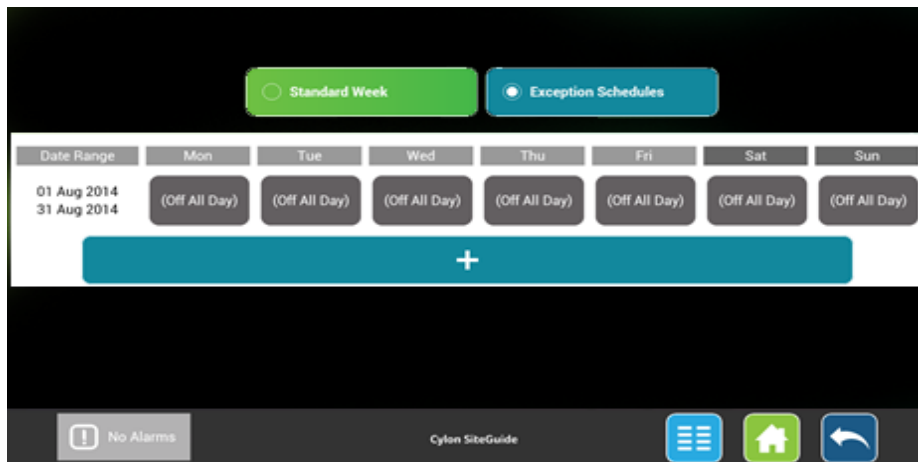

2. **The Standard Week:** The Standard Week on/off times apply on days where no Exception applies (typical day to day schedule). Each day of the Standard Week can have multiple on/off time pairs. The Standard week does not have a date range:

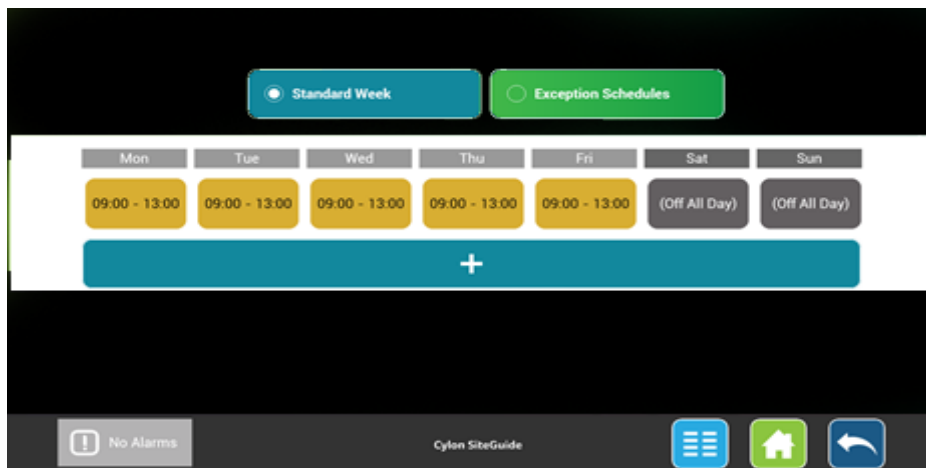

### HOW TO OPEN A SCHEDULE FOR EDITING

Click on the menu item that refers to the schedule.

### HOW TO VIEW STANDARD OR EXCEPTION TIMES FOR THE SELECTED SCHEDULE

To view the current schedule's Standard Week or Exceptions, click the relevant button at the top of the Schedule screen:



## HOW TO EDIT ONE OR MORE ON/OFF TIME PAIRS

Touching an on/off pair in the Comms Schedule display - either on the Standard Week or the Exception List page - will open the on/off time pair editor

Standard Week

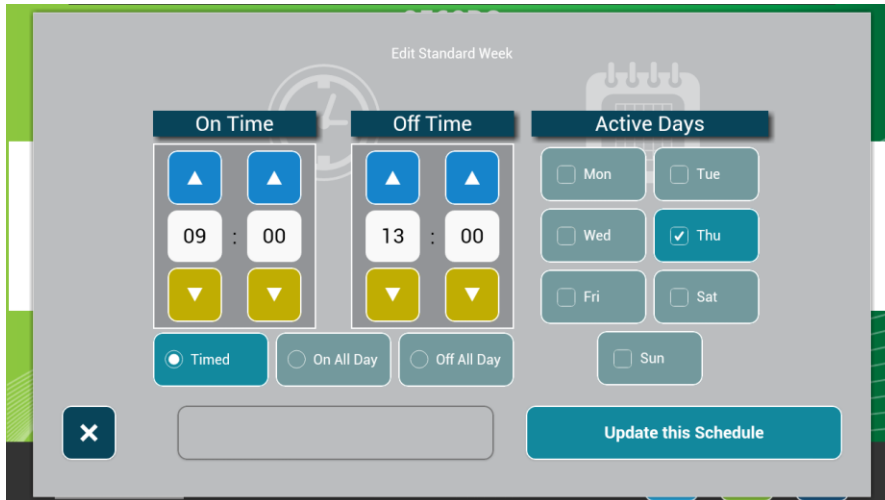

Exception

The Exception editor includes a date range section:



Date Range

On/off time pairs within a Standard Week do not have a Time Period associated with them.

An exception must operate within a limited time period of one or more days. Separate date pickers are provided to specify the start and end of this period:

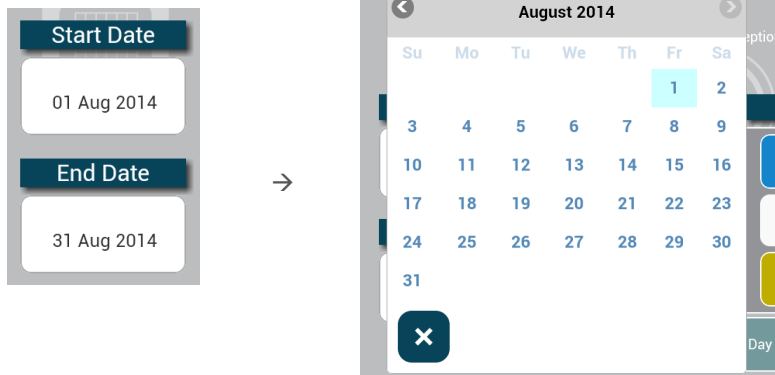

The **End Date** must not be before the **Start Date**.

#### Active Days

The times specified in this editor will apply only on weekdays selected in the Active Days picker:

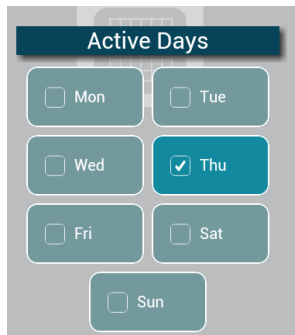

If a date range applies (i.e. an Exception) and the range is less than a week, then only weekdays within that range can be selected

#### Schedule activity within a day

The active times for the schedule on the selected days can be specified in 3 ways:

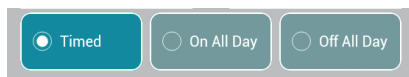

- **On All day:** the schedule will be active from 00:00 to 24:00 on each of the specified days.
- **Off all day:** the schedule will be inactive from 00:00 to 24:00 on each of the specified days.
- **Timed:** the schedule will be active between the specified **On Time** and **Off Time**.
  - There are separate spinners for the hours and minutes of both the **On Time** and the **Off Time**.
  - The **Off Time** must not be earlier than the **On Time**.

## DATE&TIME

You can edit the Time and Date of the Comms Controller by clicking on the **Date and Time** item in the **Main Menu**, if it has been enabled in the keypad program:



How to change the Controller date

Touch the **date input** to open a **date picker**

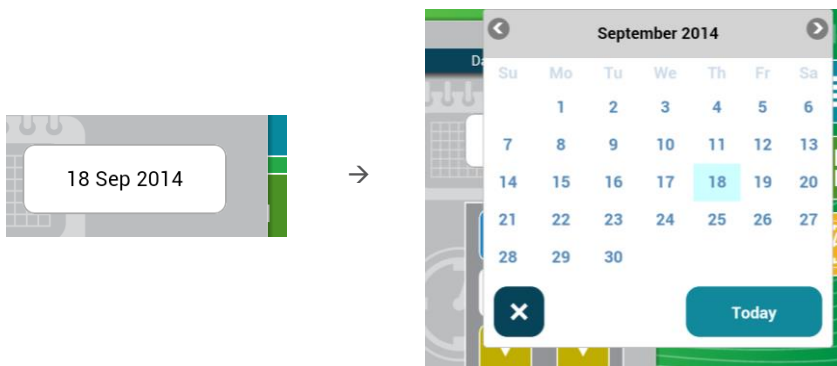

How to set the Controller time

There separate spinners for setting the Hour and the Minutes:

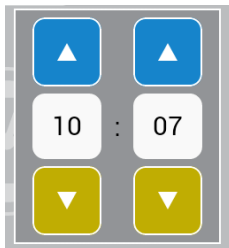

How to apply the selected time and date

To set the Controller's time and date to match the chosen values, touch the



To leave the Controller's time and date unchanged, click the **Cancel button**



## SITEGUIDE MENU ICONS

### MENU LAYOUT

SiteGuide V2.2 displays each menu as a description block and an icon.

If the description contains a term that refers to one of the preconfigured icons recognized by SiteGuide V2.2 (see *Preconfigured Icon list* below), that icon will be displayed.

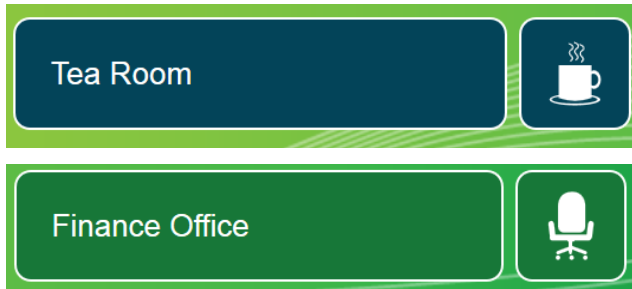

If not, the icon displayed will be selected in sequence from a number of generic icons (see *Generic Icons* below).

## GENERIC ICONS

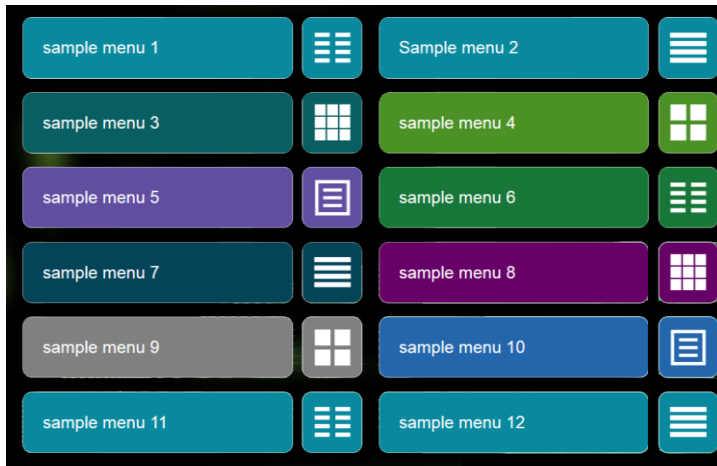







## PRECONFIGURED ICON LIST

Here is a list of the terms that are recognized, and the icon that will be displayed for each:

1 cafe 	2 tea 	3 coffee 	4 time schedule 	5 schedule 
6 outside temperature 	7 temperature 	8 datalog 	9 kitchen 	10 dining 
11 lunch 	12 office 	13 meeting 	14 classroom 	15 boiler 
16 plant 	17 thermostat 	18 AC control 	19 Air Con 	20 gas 
21 water tap 	22 electricity 	23 weather 	24 lights 	25 lighting 
26 fan 	27 HVAC 	28 ventilation 	29 AHU 	30 meter 
31 energy 	32 CO2 	33 heat 	34 cool 	35 air quality 
36 security 	37 cctv 	38 lux level 	39 humidity 	40 pump 
41 toilet 	42 bathroom 	43 lift 	44 window 	45 blinds 
46 lock 	47 key 	48 underfloor heating 	49 solar panel 	50 exterior lights 
51 computer 	52 alarm 	53 fire alarm 	54 hot water storage 	55 pir 
56 water 	57 swimming 	58 recycled water 	59 waste 	60 library 
61 light switch 	62 wall plug 	63 socket 	64 fridge freezer 	

If a menu description contains more than one of the recognized terms, then the longest match will be used. For example “Site Office Temperature” will match “temperature”, but “Site Outside Temperature will match “outside temperature”.

Here are some illustrations of how this matching behaves with different mixes of recognized terms:

Menu Description text	Matched term	Icon
meeting office schedule	"schedule"	
meeting office temperature time schedule	"time schedule"	
meeting office temperature schedule	"temperature"	
meeting office outside temperature schedule	"outside temperature"	
meeting office outside temperature time schedule	"outside temperature"	
meeting time schedule office outside temperature	"outside temperature"	

## 4 ASPECT® HTML Interface

The eXplore unit can display an ASPECT® HTML5 interface:

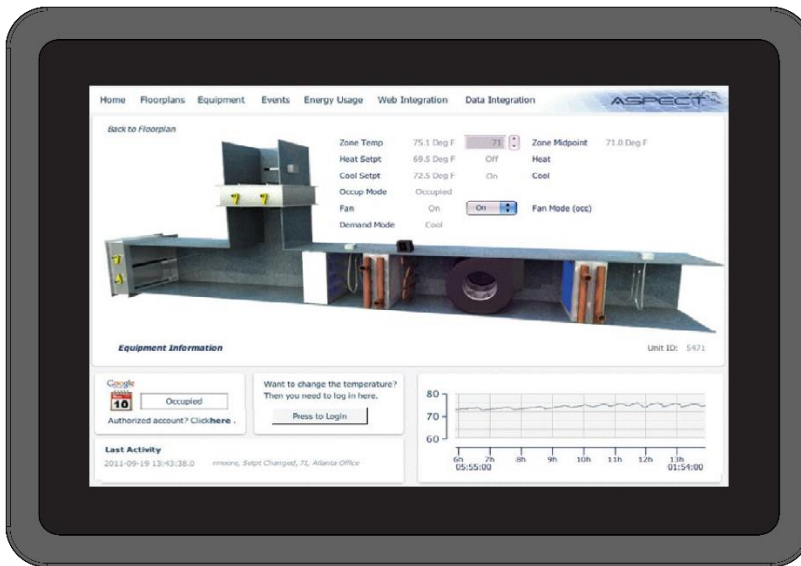

The ASPECT® HTML5 interface is generated by ASPECT®-Studio See Cylon Manual *MAN0129 ASPECT-Studio* help for full details.

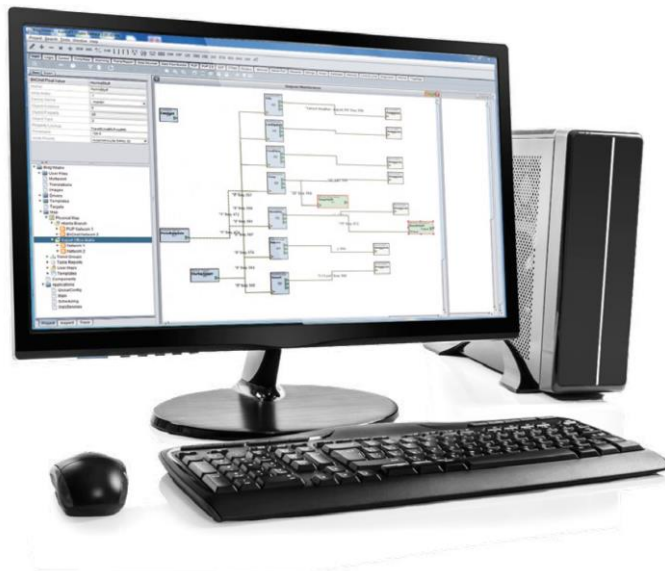





---

ABB CYLON CONTROLS

Clonshaugh Business & Technology Park  
Clonshaugh  
Dublin 17  
Ireland

Tel.: +353 1 245 0500  
Fax: +353 1 245 0501  
Email: [info@cylon.com](mailto:info@cylon.com)

---

ABB CYLON CONTROLS

ONE TECHNOLOGY LANE  
EXPORT,  
PA 15632

Tel.: +1 724 733-2000  
Fax: +1 724 327-6124