

USER GUIDE

MAN0106 rev 56

# ABB Cylon® BACnet



### Style conventions used in this document:

**UI Text:** Text that represents elements of the UI such as button names, menu options etc. is presented with a grey background and border, in Tahoma font which is traditionally used in Windows UIs. For example:

Ok

**Standard Terms (Jargon):** Text that is not English Language but instead refers to industry standard concepts such as Strategy, BACnet, or Analog Input is represents in slightly condensed font. For example:

BACnet

**Code:** Text that represents File paths, Code snippets or text file configuration settings is presented in fixed-width font, with a grey background and border. For example:

```
$config_file = c:\CYLON\settings\config.txt
```

**Parameter values:** Text that represents values to be entered into UI fields or displayed in dialogs is represented in fixed-width font with a shaded background. For example

10°C

**Product Names:** Text that represents a product name is represented in bold colored text. For example

**INTEGRA™**

**Company Brand names:** Brands that are not product names are represented by bold slightly compressed text:

**ABB Active Energy**

**PC Keyboard keys:** Text representing an instruction to press a particular key on the keyboard is enclosed in square brackets and in bold font. For example:

**[Ctrl]+[1]**

# table of contents

|          |   |           |
|----------|---|-----------|
| <b>1</b> | <b>INTRODUCTION</b>                                       |           |
|          | Overview of the Cylon BACnet System .....                 | 6         |
|          | System Requirements.....                                  | 6         |
|          | <b>An introduction to BACnet.....</b>                     | <b>7</b>  |
|          | What is BACnet? .....                                     | 7         |
|          | BACnet object types.....                                  | 8         |
|          | BACnet services .....                                     | 8         |
|          | BACnet's Client / Server nature.....                      | 9         |
|          | Network Types.....  | 9         |
|          | PIC Statement.....  | 10        |
|          | BACnet Topology .....                                     | 10        |
|          | BACnet/IP Broadcast Management Device (BBMD).....         | 11        |
| <b>2</b> | <b>THE CYLON BACNET ROUTER</b>                            |           |
|          | <b>The Cylon BACnet Router (CBR).....</b>                 | <b>12</b> |
|          | <b>Configuring the CBR.....</b>                           | <b>14</b> |
|          | BACnet Router Setup - 'Home' page .....                   | 14        |
|          | BBMD page .....   | 17        |
|          | System page.....  | 18        |
|          | <b>Modbus.....</b>  | <b>19</b> |
|          | What is Modbus?.....                                      | 19        |
|          | Modbus in the CBR .....                                   | 19        |
|          | <b>Configuring Modbus Devices.....</b>                    | <b>20</b> |
|          | Modbus Port Settings.....                                 | 21        |
|          | Devices and Point mapping .....                           | 21        |
| <b>3</b> | <b>BACNET FIELD CONTROLLERS</b>                           |           |
|          | <b>Main Plant controllers .....</b>                       | <b>24</b> |
|          | CBM LED Signals .....                                     | 25        |
|          | <b>Unitary Controllers (CBT range) .....</b>              | <b>25</b> |
|          | CBT Indicator LED Signals.....                            | 27        |
|          | CBT12iVAV, CBV-2U4-3T and CBT-4T4-4T .....                | 28        |
|          | CBT-3T6-5R.....   | 29        |
|          | CBT-4T4-2U1R .....  | 30        |
|          | <b>CBX-8R8 and FLX-8R8 .....</b>                          | <b>31</b> |
|          | Dimensions .....  | 31        |
|          | Wiring.....   | 31        |
|          | Terminals.....  | 32        |
|          | CBX and FLX Indicator LED Signals .....                   | 34        |
|          | <b>Power Supply UNIT: FLX-PS24.....</b>                   | <b>35</b> |
|          | Dimensions and wiring:.....                               | 36        |
| <b>4</b> | <b>INSTALLATION</b>                                       |           |
|          | <b>Wiring notes .....</b>                                 | <b>37</b> |
|          | <b>How to connect CBM and CBT Field Controllers .....</b> | <b>38</b> |
|          | Connecting 24 V AC Power supply .....                     | 38        |
|          | Connecting Network Bus.....                               | 39        |
|          | Connecting Input Ports.....                               | 40        |
|          | Connecting UniPut Ports .....                             | 41        |

## table of contents

|  |  |
|--|--|
| <b>How to Connect CBX controllers</b> .....  | 42   |
| Apply power to the CBX-8R8(-H) .....   | 42   |
| Connect the CBX to the MS/TP Network .....   | 44   |
| Configure the CBX-8R8(-H) for BACnet® communications .....   | 45   |
| Connect the CBX-8R8(-H) to FLX units .....   | 47   |
| <b>CBX Operation</b> .....   | 50   |
| Inputs and Outputs .....   | 50   |
| Auxiliary Power outputs .....  | 54   |
| Using a Keypad with the CBX .....  | 54   |
| Output Override .....  | 54   |
| <br>   |  |
| <b>5</b>   | <b>CONFIGURING THE CYLON BACNET SYSTEM</b> |
| <b>How to install Cylon Engineering Center software</b> .....  | 56   |
| <b>How to configure Cylon BACnet Field Controllers</b> .....   | 59   |
| Step 1: Choose a Network Adapter for BACnet comms.....   | 59   |
| Step 2: Set up the Site in the <b>Engineering Center</b> .....   | 60   |
| Step 3: Configure the Controller's BACnet settings .....   | 67   |
| Step 4: Specify the points that are to be exposed on the BACnet system .....                                 | 72   |
| Step 5: Download the Configuration to the Controller .....   | 73   |
| Step 6: View BACnet points from the Controller .....   | 74   |
| <b>Bacnet Explorers</b> .....  | 75   |
| NB-Pro .....   | 75   |
| Discovery Tool .....   | 75   |
| <b>Building a Strategy</b> .....   | 81   |
| Overview .....   | 81   |
| "Points" and Point Numbers .....   | 82   |
| BACnet Time Schedule .....   | 83   |
| Appearance .....   | 83   |
| Function .....   | 83   |
| Parameters .....   | 84   |
| BACnet Alarm block .....   | 86   |
| BACnet Trendlog block .....  | 88   |
| Parameters .....   | 88   |
| 3 <sup>rd</sup> Party Point blocks – [3 <sup>rd</sup> Party Analog] and [3 <sup>rd</sup> Party Binary] ..... | 91   |
| Priority Array Blocks – [Anlg PA] and [Bnry PA] .....  | 95   |
| <b>Backing up the BACnet Site</b> .....  | 98   |
| Backing up the CBR routers .....   | 98   |
| How to restore a CBR router .....  | 98   |
| <br>   |  |
| <b>6</b>   | <b>APPENDICES</b>                          |
| <b>Appendix – BACnet Parameters</b> .....  | 102  |
| <b>Appendix - Understanding BACnet MS/TP</b> .....   | 103  |
| Communication on an MS/TP Fieldbus .....   | 103  |
| Scenarios .....  | 105  |
| <b>Appendix: Quickstart Guide</b> .....  | 106  |
| Background.....  | 106  |
| Method 1: The VT100 Terminal Interface.....  | 106  |
| Method 2: NetLink.....   | 108  |
| Method 3: Cylon Engineering Center.....  | 108  |
| Method 4: Via BACnet MS/TP .....   | 110  |
| Method 5: CBT-STAT (CBT12iVAV only).....   | 111  |
| <b>Appendix – Troubleshooting</b> .....  | 113  |

## table of contents

|  |            |
|--|------------|
| <b>Appendix: Maximizing Strategy Download performance.....</b>             | <b>115</b> |
| Update in parallel .....   | 116        |
| Wipe all of the Controllers .....  | 116        |
| Quieten controllers using DCC.....   | 117        |
| <b>Appendix: Engineering Data Exchange (EDE) .....</b>                     | <b>118</b> |
| Overview .....   | 118        |
| Full EDE export.....   | 118        |
| Partial EDE Export.....  | 120        |
| <b>Appendix : Using an Optimizer macro with BACnet .....</b>               | <b>122</b> |
| <b>Appendix: Protocol Implementation Conformance Statement (PICS).....</b> | <b>123</b> |
| CBR (UC32.net BACnet IP-to-MSTP Router) .....                              | 123        |
| CBM and CBX Main Plant Controllers and CBT Unitary Controller .....        | 131        |
| <b>Appendix: Proprietary BACnet Properties.....</b>                        | <b>147</b> |

# 1 Introduction

## OVERVIEW OF THE CYLON BACNET SYSTEM

Cylon provides a complete BACnet solution: a BACnet IP to BACnet MS/TP router, and a number of Field Controllers that are capable of exposing points to a BACnet network, so that they can be installed on a BACnet MS/TP fieldbus.

This document explains how to set up a **Cylon BACnet** system: how to configure the **Cylon BACnet** router, which Field Controllers to use and how to configure the BACnet-specific features of those controllers.

## SYSTEM REQUIREMENTS

Cylon BACnet includes the following system components:

| Routers   | Main Plant Controllers   | Unitary Controllers   | Configuration   | Supervision   |
|---|--|---|---|---|
| <ul style="list-style-type: none"> <li>Cylon BACnet Router IP-to-MS/TP (CBR)</li> <li>Matrix</li> <li>Nexus</li> <li>Integra</li> </ul> | <ul style="list-style-type: none"> <li>CBX-8R8</li> <li>CBM24</li> <li>CBM16</li> <li>CBM12</li> <li>CBM8</li> </ul> | <ul style="list-style-type: none"> <li>CBT12iVAV</li> <li>CBV-2U4-3T</li> <li>CBT-4T4-2U1R</li> <li>CBT-3T6-5R</li> </ul> | <ul style="list-style-type: none"> <li>CXpro<sup>HD</sup> or Engineering Center (EC) v6.75 or later</li> <li>Cylon BACnet dongle</li> <li>CBT-STAT</li> </ul> | <ul style="list-style-type: none"> <li>Aspect Enterprise</li> <li>Integra Supervisor</li> </ul> |

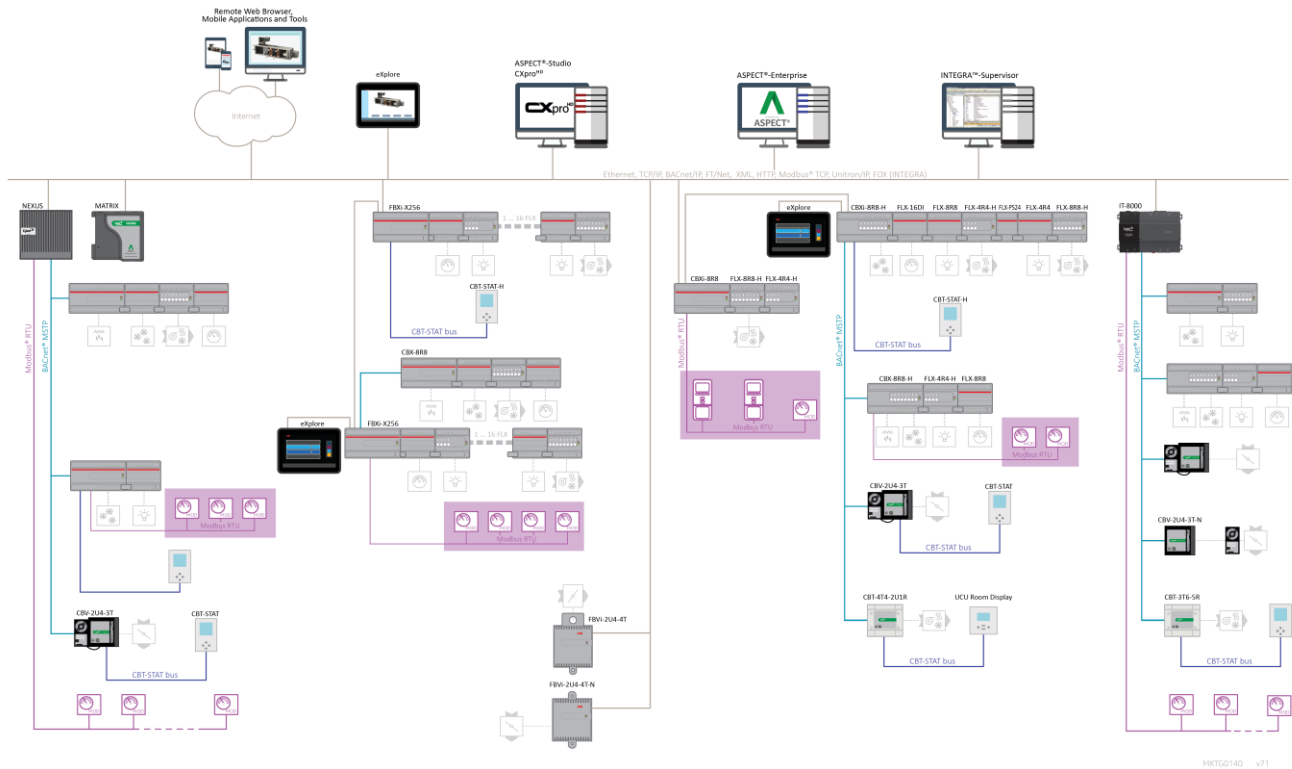

## AN INTRODUCTION TO BACNET

### WHAT IS BACNET?

BACnet is "a data communication protocol for building automation and control networks." This means it is a set of rules for exchanging BMS information between systems from different manufacturers.

The rules take the form of a written specification that spells out what is required to conform to the protocol

The key feature of BACnet is that the rules relate specifically to the needs of building automation and control equipment - for example, how to ask for the value of a temperature, define a fan operating schedule, or send a pump status alarm.

BACnet provides a standard way of representing the functions of any device - for example analog or binary inputs or outputs, schedules, control loops and alarms.

The standardized model of a device represents these common functions as collections of related information called objects

Each object has a set of properties that further describe it. Each analog input, for instance, is represented by a BACnet "Analog Input object", which has a set of standard properties such as 'Present Value', 'Sensor Type', 'Location', 'Alarm Limits' etc. Some of these properties are required, while others are optional.

The only required object in each BACnet controller is the Device object. This object contains the properties that define the controller's behavior on the network. Each controller's Device object has an associated number called the Device Instance. It is this unique number that allows all other BACnet devices to unambiguously access the controller.

Here is an illustration of BACnet objects:

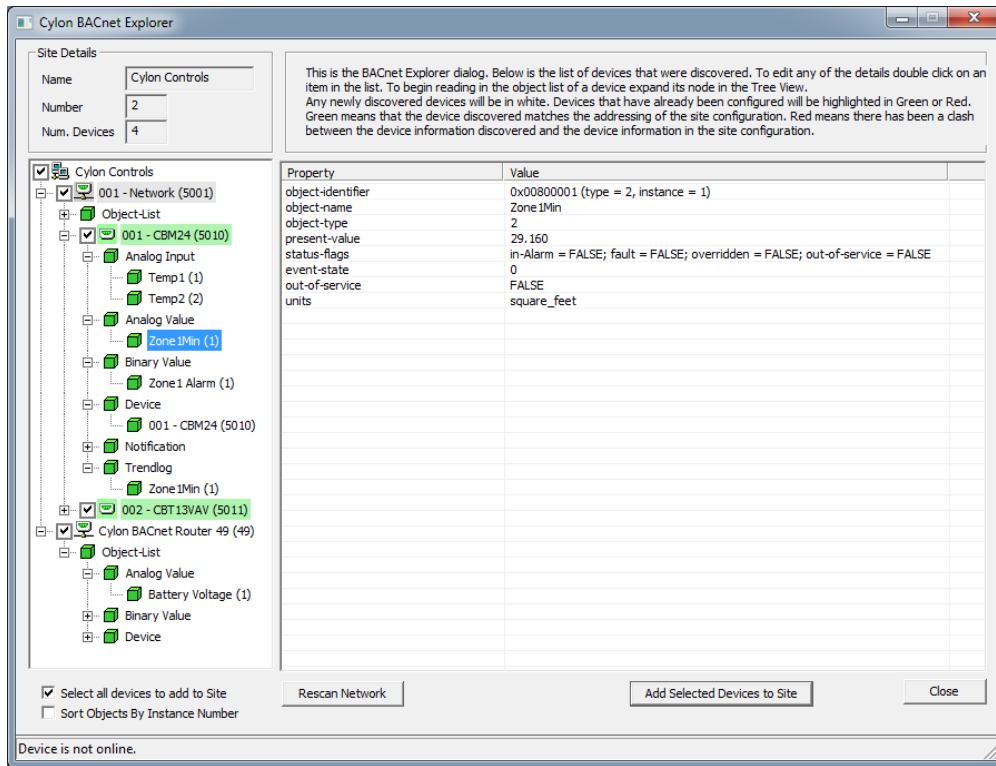

### BACNET OBJECT TYPES

The BACnet standard defines a number of standard object types, and this number is increasing over time. Cylon uses the following standard types (\* indicates that the object is proprietary):

- Device
- Analog Input
- Analog Value
- Analog Output
- Binary Input
- Binary Value
- Binary Output
- Schedule
- Calendar
- Unitron Schedule \*
- Notification Class
- File
- Trend Log
- Manufacturing Object \*

### BACNET SERVICES

The BACnet standard defines numerous services for interaction between BACnet devices. The following are supported by Cylon BACnet products:

- ReadProperty
- WriteProperty
- ReadPropertyMultiple
- WritePropertyMultiple
- Read Range
- WhoIs
- IAm
- WhoHas
- IHave
- UnconfirmedPrivateTransfer
- TimeSynchronization
- UTCTimeSynchronization
- DeviceCommunicationControl
- ReinitializeDevice
- AtomicWriteFile
- AtomicReadFile
- AcknowledgeAlarm
- GetAlarmSummary
- GetEventInformation
- ConfirmedEventNotification
- UnconfirmedEventNotification
- SubscribeCOV
- ConfirmedCOVNotification
- UnconfirmedOVNotification



## BACNET'S CLIENT / SERVER NATURE

BACnet uses a "Client/Server" architecture. BACnet messages are called service requests. A Client machine sends a service request to a Server machine that then performs the service and reports the result to the Client.

### Example:

A simple device such as a fixed function VAV controller would typically act as Server.

Front-end software running on a PC would act as a BACnet Client reading status values from the VAV and changing set-points.

### Notes:

Server devices can not initiate communication. Higher end embedded controllers generally include both server and client functionality. This allows them to share information such as outside temperature with each other, or send alarms to a PC.

BACnet currently defines 35 message types that are divided into 5 groups or classes. For example, one class contains messages for accessing and manipulating the properties of the objects described above.

A common message type is the "ReadProperty" service request. This message causes the server machine to locate the requested property of the requested object and send its value back to the client.

Other classes of services deal with: alarms and events, file uploading and downloading, managing the operation of remote devices and virtual terminal functions.

## NETWORK TYPES

BACnet messages can be carried over the following types of network:

- Ethernet
- ARCnet
- Master-Slave/Token-Passing (MS/TP)
- Point-to-Point (PTP)
- LON
- BACnet/IP

## PIC STATEMENT

Every BACnet device is required to have a "protocol implementation conformance statement" (PICS). A PICS is a BACnet specification sheet, containing a list of a device's BACnet capabilities.

It contains:

- a general product description
- details of a product's BACnet capabilities
- which LAN options are available
- a few other items relating to character sets and special functionality

The PICS is the place to start to see what a device's capabilities are.

## BACNET TOPOLOGY

A typical BACnet Network consists of devices connected to physical networks. Each device is a separate piece of hardware, and has a physical connection to the network. Devices are given a unique Device Instance Number which can be a number between 0 and 4194302. BACnet MS/TP devices have additional addressing designations called MAC addresses. For most users it is the Device Instance Number which is used as a reference, but the combination of the Network Number and MAC address of an MS/TP device may be configured by a System Integrator to avoid any MAC address conflicts on the EIA-485 network.

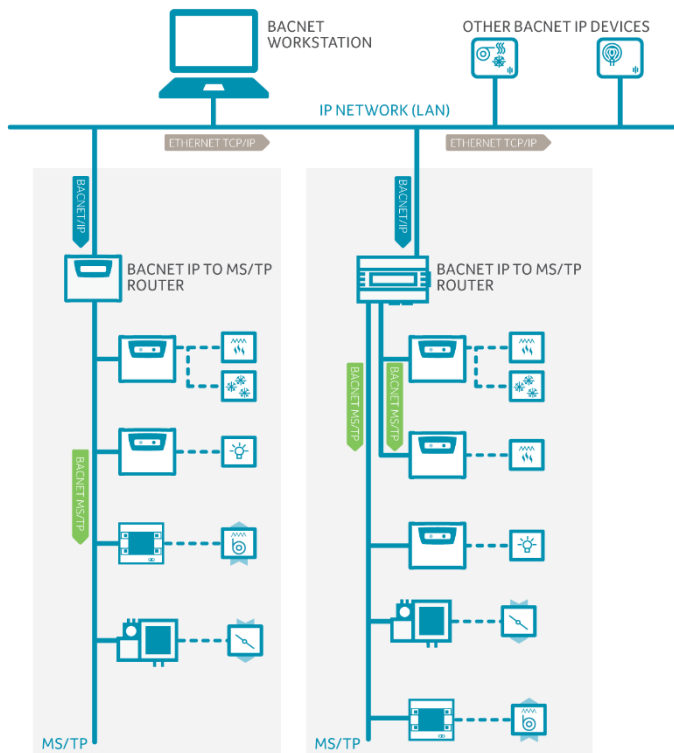

## BACNET/IP BROADCAST MANAGEMENT DEVICE (BBMD)

Some BACnet services use “broadcasts” (e.g. “Who-Is”). On a LAN with standard routers these broadcasts are “blocked”. Thus BACnet broadcasts are limited the IP Subnet of the BACnet device. With a BACnet/IP network of 2 or more IP subnets a device with BBMD can be used.

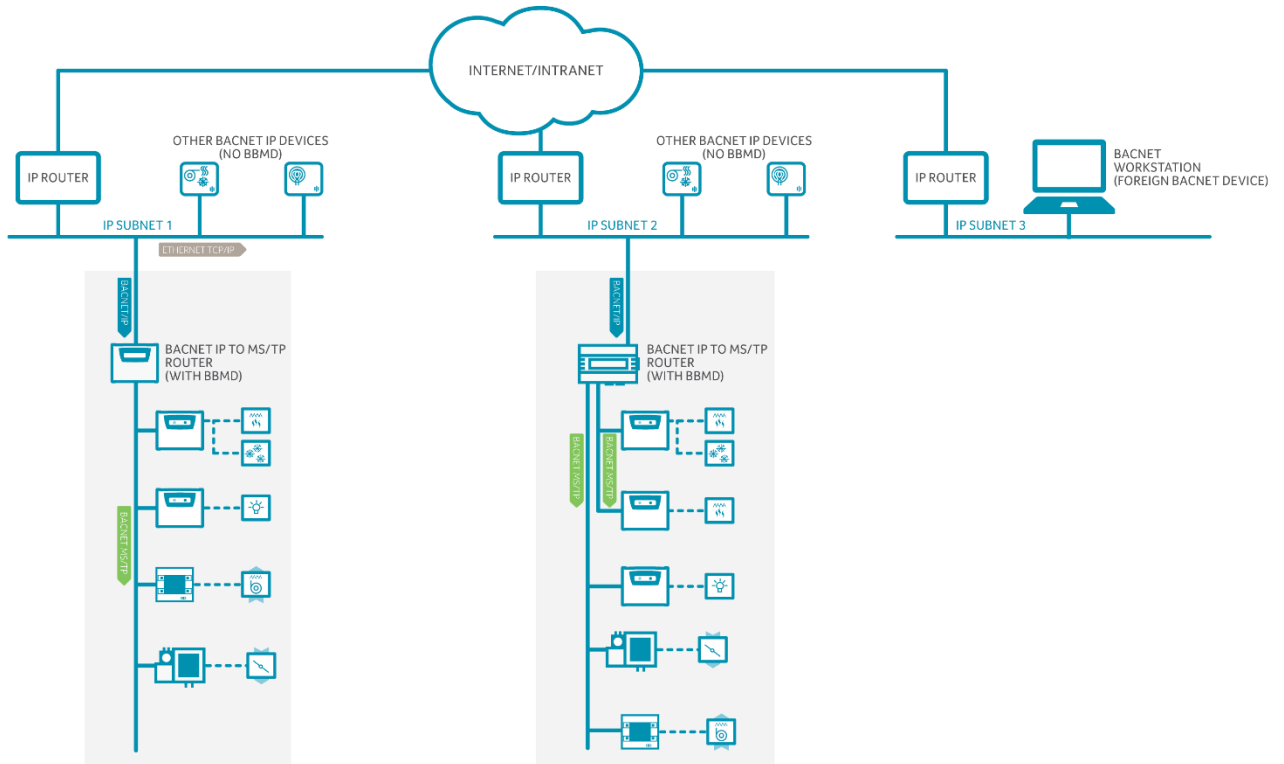

A BBMD located on an IP subnet monitors the origin of a broadcast message on that subnet and, in turn, constructs a “peer to peer” *message* in order to pass through an IP router. This “peer to peer” message is received by other BBMDs on other IP subnets and transmitted as a broadcast on their attached subnets.

Since the BBMD messages are directed messages, individual messages must be sent to each BBMD. Each BBMD device maintains a *Broadcast Distribution Table (BDT)*, the content of which is usually the same for all BBMDs within the network. BBMDs must know the IP address of all other BBMDs in the network.

It is possible to communicate to a device on a subnet that does not have a BBMD as in the BACnet Workstation example above. This type of device is called a foreign device since it resides on a different IP subnet from devices attempting to communicate with it.

Usually in BACnet/IP a foreign device is on a different subnet.

The foreign device (e.g. BOWS) registers with each BBMD, after which it can communicate with all other devices on the network. The BBMD then maintain a Foreign Device Table (FDT) which keeps track of foreign devices.

## 2 The Cylon BACnet Router

### THE CYLON BACNET ROUTER (CBR)

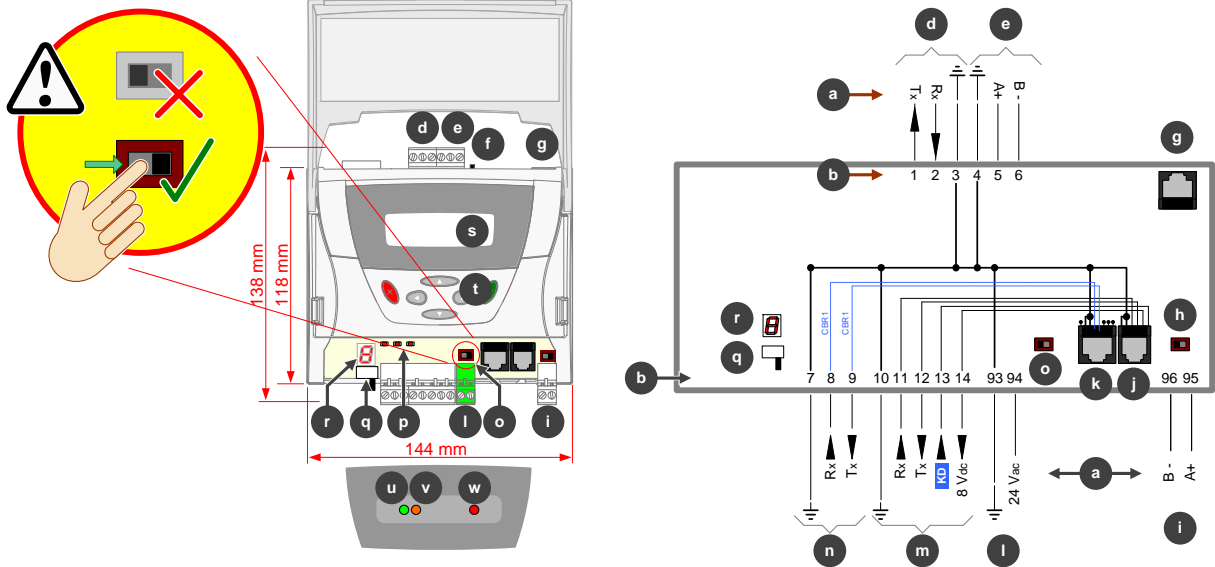

**Important:** The Battery Enable Switch (located above the Power 24 V AC connection) must be switched to the "Battery Enabled" position to ensure backup of controller settings when the device is powered down. Press the "up" key  on the keypad to check the battery status.



**CAUTION** - DANGER OF EXPLOSION IF BATTERY IS INCORRECTLY REPLACED. REPLACE ONLY WITH THE SAME OR EQUIVALENT TYPE RECOMMENDED BY THE MANUFACTURER. DISPOSE OF USED BATTERIES ACCORDING TO THE MANUFACTURER'S INSTRUCTIONS.

**KD**

Keypad Detect



Common

**a**

Point Numbers

**b**

Terminal Numbers

**d**

Modbus RS232 (port 4) (modbus variants only)

**e**

Modbus RS485 (port 4) (modbus variants only)

**g**

Ethernet 10/100 Mb

**h**

Fieldbus Terminator



- ON (fieldbus terminated at this controller)



- OFF (fieldbus not terminated at this controller)

**i**

Fieldbus Port

**j**

External Keypad port (RJ-12)

**k**

Service port/Printer port (port 1) (quick-connect RJ-45)

**l**

Power 24 V AC

**Important:** Earth this controller by connecting the common wire ( $G_0$  ) on the secondary side of the 24 V AC transformer to Earth at one point.

**m**

External Keypad port (screw terminal)

**n**

Service port/Printer port (port 1) (screw terminal)

**o**

Battery enable Switch





- Battery Disabled



- Battery Enabled

**p**

Ethernet Indicator LEDs

|         |  Traffic |  Collision |  Link |
|---------|---|---|--|
| LED on  | Ethernet message received   | Collision detected  | Ethernet is connected  |
| LED off | No incoming Ethernet messages   | No collision detected   | Ethernet is not connected  |

**q**

Fieldbus port 2 Terminator



- ON (fieldbus terminated at this controller)



- OFF (fieldbus not terminated at this controller)

**r**

7-segment LED display (controller status)

**u**

MS/TP Status

**v**

Battery Status

**w**

Power LED

- Red = on

## Factory Configuration Options:

|           | Maximum number of Modbus devices | Maximum no. of Modbus points |
|-----------|----------------------------------|------------------------------|
| CBR       | 0                                | 0                            |
| CBR/MOD   | 48                               | 1600                         |
| CBR/MODex | 122                              | 1600                         |

**Note:** Devices with a fractional (¼ or better) unit load will be required to reach the number of Modbus devices limit.

**⚠ Important:** The Battery Enable Switch  must be switched to the "Battery Enabled" position to ensure backup of configuration settings, and to keep the real-time clock operating when the device is powered down.

The **CBR** uses battery backed-up memory to save configuration data and keep the real time clock operating. The on board battery will maintain the real time clock and configuration data for 6 months without power.

To save battery life before installation the units are shipped from the factory with the battery disabled. **When the unit is installed you must enable the battery.** This is done via the Battery Enable Switch. The real time clock and configuration should then be configured.

If the battery is disabled when the **Cylon BACnet Router** is powered up, the 7-segment display will display "b" alternating with "E" and the orange Status LED will flash.

During operation, if the battery is disabled the orange Status LED will turn on.

If power is maintained when the Battery is disabled then the configuration data and the real time clock will be maintained.

If the Battery is disabled when the **Cylon BACnet Router** is powered down, then the next time Power is applied the configuration and real time clock will be "wiped". Note that the Network Setup (IP Address etc.) will not be "wiped" after this procedure.

To restore the default Network Setup, power up the **CBR** with the Battery enabled, then disable it for between 3 and 4 seconds as follows:

Disable the Battery using the Battery Switch. (The orange Status LED will turn on)

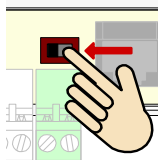

Wait for 3 seconds, then ...

Within 1 second enable the battery. (The orange Status LED will turn off)

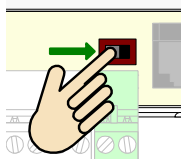

After a short delay (less than 10 seconds) the device will restart with the default Network Setup (IP address = [192.168.1.1](#)).

## CONFIGURING THE CBR

The CBR is configured via web pages.

The default Network configuration uses an IP Address of 192.168.1.1 and a Subnet Mask of 255.255.255.0.

The default username/password is admin/admin.

### BACNET ROUTER SETUP - 'HOME' PAGE

The screenshot shows the 'BACnet Router Setup' web interface. It is divided into several sections:

- Device properties:** Fields for Device Name (004 First Floor BACnet Fan Coils), Device Description (BACnet/IP to BACnet MS/TP Router), Device Location (Comms Room), Device ID (40000), BACnet/IP Port (47808), and BACnet Network Number - BACnet/IP (50).
- MSTP properties:** Fields for MSTP Address (0), BACnet Network Number - MSTP (51), Max Masters (127), Max Info Frames (20), and Baudrate (76800).
- Virtual BACnet Network:** Field for BACnet Network Number - Modbus (1051).
- Network properties:** Fields for IP Address (192.168.3.45), Subnet Mask (255.255.255.0), Default Gateway (192.168.3.253), and Ethernet MAC Address (000FEB-00501C).
- Time properties:** Fields for Date & Time (Thu, 16 Jul 2015 09:33:31), Daylight Savings (radio buttons for None, EU, US), a 'Send Time' button, and Auto. Time Sync. Send Interval (3 hours, 0 minutes).

The Home page allows the following parameters to be configured:

#### BACnet Setup

| Parameter name                    | Description  | Permitted values   | Default value               |
|-----------------------------------|--|--------------------|-----------------------------|
| Device Name                       | Unique name for the BACnet device. This is a text reference which must be unique across the BACnet network. The Device Instance Number is appended to this name to help ensure it is unique. | 63 characters max. | "BACnet/IP to MS/TP Router" |
| Device Description                | Text string description of BACnet device   | 63 characters max. | "BACnet/IP to MS/TP Router" |
| Device Location                   | Text string location of BACnet device  | 63 characters max. | " "                         |
| Device Instance Number (Instance) | The BACnet device instance of the router. The number must be unique across the entire BACnet inter-network.  | 0 to 4194302       | 49                          |
| BACnet/IP Port                    | The BACnet/IP port for the router  | 1024 to 65535      | 47808                       |
| BACnet Network Number             | The BACnet/IP network number   | 1 to 65534         | 50                          |

### MS/TP Properties

| Parameter name               | Description  | Permitted values                          | Default value |
|------------------------------|--|---|---------------|
| MSTP Address                 | The router's MS/TP port MAC address  | 0 to 127                                  | 0             |
| BACnet Network Number - MSTP | The router's BACnet MS/TP network number. Each BACnet network should have a unique number  | 1 to 65534                                | 51            |
| Max Masters                  | Use to tell the router the maximum MS/TP address used on the MS/TP fieldbus.<br><b>Note:</b> <i>this is usually only set on the last device on the MS/TP network</i> | 1 to 127                                  | 127           |
| Max Info Frames              | Use to limit the number of "messages" the router will route on to the MS/TP network per token pass   | 1 to 100                                  | 20            |
| Baud rate                    | The baud rate used by the router MS/TP port  | 9600, 19200, 38400, 76800, 115200, 153600 | 38400         |

### Virtual BACnet Network

| Parameter name                 | Description  | Permitted values | Default value |
|--------------------------------|--|------------------|---------------|
| BACnet Network Number - Modbus | The router's BACnet Modbus network number. Each BACnet network should have a unique number | 1 to 65534       | 1051          |

### Network Properties

| Parameter name       | Description                                  | Default value |
|----------------------|--|---------------|
| IP Address           | IP address in dotted decimal format          | 192.168.1.1   |
| Subnet Mask          | IP subnet mask in dotted decimal format      | 255.255.255.0 |
| Default Gateway      | IP gateway address in dotted decimal format  | 0.0.0.0       |
| Ethernet MAC Address | The Routers Ethernet MAC Address (Read Only) | Factory Set   |

### Time Properties

| Parameter name   | Description  | Default value     |
|--|--|-------------------|
| Date & Time  | Date & Time  | Current Time/Date |
| Send time to the MS/TP network now                               | Send time/date to all devices on the MS/TP network |                   |
| Auto. Time Sync. Send Interval (hours : minutes, 0:0=don't send) | Set automatic time sync interval                   | 0:0 (Don't Send)  |

**Note:** To view the configured IP settings, a UCKRA420 external keypad can be used. The IP settings can also be configured with the external keypad.

## How to restore the default Network Setup:

To restore the default network setup power up the **Cylon BACnet Router** (with the Battery enabled) and use the following steps.

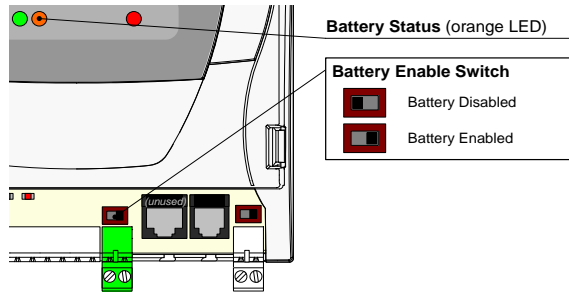

1. Disable the battery using the battery switch. (The orange status LED will turn on)
2. Wait for 3 seconds, then ...
3. **Within 1 second** enable the battery. (The orange status LED will turn off)

After a short delay (less than 10 seconds) the device will restart with the default network setup.



## BBMD PAGE

The **CBR** can pass messages from controllers on its fieldbus to controllers on other fieldbuses in 2 ways:

1. It can act as a BACnet/IP Broadcast Management Device (BBMD), which communicates with other BBMDs, and
2. It can communicate directly with controllers on fieldbuses that do not have a BBMD (these are known as “Foreign Devices”).

### What is BBMD?

Some BACnet services (e.g. “Who-Is”) use ‘broadcasts’. These broadcasts are blocked by standard Ethernet routers, so that BACnet broadcasts are limited to the IP subnet of the BACnet device. A BACnet/IP Broadcast Management Device (BBMD) is one way to get around this limitation on a BACnet/IP network of 2 or more IP subnets.

### How a BBMD operates

A BBMD located on an IP subnet monitors broadcast message on that subnet, and constructs a “peer to peer” message for each broadcast to pass it through any IP router. This “peer to peer” message is received by other BBMDs on other IP subnets and transmitted as a broadcast on their attached subnets.

Since the BBMD messages are ‘directed’, individual messages must be sent to each BBMD. Each BBMD device maintains a Broadcast Distribution Table (BDT), the content of which is usually the same for all BBMDs within the network. Each BBMD must know the IP address of every other BBMD in the network.

### Foreign Devices

It is possible to communicate with a device on a subnet that does not have a BBMD device (e.g. a BOWS). This type of device is called a foreign device since it resides on a different IP subnet from the device that is attempting to communicate with it.

Usually in BACnet/IP a foreign device is on a different subnet, but this is not a requirement.

The foreign device registers with each BBMD, after which it can communicate with all other devices on the network. The BBMD then maintains a Foreign Device Table (FDT) which keeps track of foreign devices.

### The CBR’s BBMD page

The BBMD page allows the Router’s Broadcast Distribution Table to be edited, to communicate with other fieldbuses that have BBMDs, and shows “Foreign Devices” that have registered with this router.

Home BBMD Modbus System

| * BACnet Broadcast Management Device Setup |              |       |                 |  |
|--|--------------|-------|-----------------|--|
| Broadcast Distribution Table               |              |       |                 |  |
| Number                                     | IP Address   | Port  | Subnet Mask     |  |
| 1  | 192.168.10.1 | 47808 | 255.255.255.255 |  |

| Foreign Device Registration List |               |       |               |                          |
|----------------------------------|---------------|-------|---------------|--------------------------|
| Number                           | IP Address    | Port  | TTL (seconds) | Remaining Time (seconds) |
| 1                                | 192.168.250.8 | 47808 | 0             | 28                       |

## SYSTEM PAGE

Home BBMD Modbus **System** iter

System Status

**Reset information**

|                              |   |
|------------------------------|---|
| <b>Run Time</b>              | 38 days,20 hours,54 mins,2 secs   |
| <b>Reset Count</b>           | 4   |
| <b>Powered Up</b>            | 27/10/2004 11:02  |
| <b>Powered Down</b>          | 09/12/2013 12:31  |
| <b>Restart Router now...</b> | <a href="#" style="background-color: #0070c0; color: white; padding: 2px 10px; border-radius: 3px;">Restart</a> |

**Hardware status**

|                                       |            |
|---------------------------------------|------------|
| <b>Backup Battery Voltage [State]</b> | 3.28V [Ok] |
| <b>Battery Switch Open</b>            | No         |
| <b>MS/TP Port 1 Terminated</b>        | No         |
| <b>Modbus Port Terminated</b>         | No         |

**Board information**

|                           |   |
|---------------------------|---|
| <b>Version</b>            | Cylon BACnet Router, ModM, MP1, 3.1C.06 (May 27 2013) |
| <b>Bootloader Version</b> | Boot 1.01   |
| <b>Serial Number</b>      | CNEM037018P   |
| <b>Sequence Number</b>    | 20508   |

Change User Setup

|   |  |
|---|--|
| <b>New Username</b> (min length 4 characters) | <input style="width: 90%;" type="text" value="admin"/> |
| <b>New Password</b> (min length 4 characters) | <input style="width: 90%;" type="password"/>           |
| <b>Confirm New Password</b>                   | <input style="width: 90%;" type="password"/>           |

The System page displays information about the Router's current status. You can Restart the Router and change the User setup from this page.

## MODBUS

### WHAT IS MODBUS?

Modbus is an open, royalty-free, industrial communication protocol, used to connect many types of electronic devices. **CBRs** can act as Remote Terminal Units on a Modbus fieldbus, using the 'Modbus RTU' version of the protocol.

### MODBUS IN THE CBR

The **Cylon BACnet Router (CBR)** is also available with Modbus capability (**CBR/MOD** or **CBR/MODex**) and can be configured for Modbus Master operation. It then acts as a gateway between Modbus RTU devices and the BACnet Network mapping Modbus devices and points (registers) to BACnet devices and BACnet points.

Modbus **CBRs** support **Serial RTU, RS232** or **RS485**, with the following capabilities:

- 1600 Modbus points
- 48 Modbus devices (**CBR/MOD**) or 122 Modbus devices (**CBR/MODex**)

**Note:** Modbus devices with fractional ( $\frac{1}{4}$  or better) unit loads will be required to reach these limits. Both **CBM** and **CBT** controllers are  $\frac{1}{4}$  unit load devices.

- Up to 255 points per Modbus device
- Template mapping for common Modbus devices

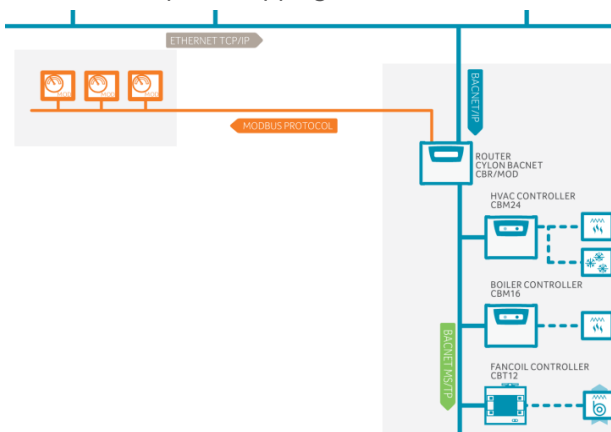

### Cable Connections

When you are using Modbus you must ensure that you are using the correct cables to connect the Comms Controllers to the third party devices. It is recommended that shielded, earthed cables are used. Modbus connections on the **CBR/MOD** are made through screw terminals. See datasheet *DS0082* for details.

## Modbus Loading

For Modbus-compatible **CBRs**, devices with a fractional ( $\frac{1}{4}$  or better) unit load will be required to reach the maximum number of Modbus devices.

**Unit Load** is a concept created by the EIA 485 specification to help determine how many devices can be connected to each fieldbus. The number of devices that can be connected depends on how much each device loads the fieldbus so the more a device loads the fieldbus, the fewer additional devices can be used. The total Unit Loads on a fieldbus must be 32 or less.

## Modbus mode and data format

Only the Modbus RTU (Remote Terminal Unit) transmission format is supported on Modbus-compatible **CBRs**. ASCII is not supported.

RS232 and RS485 are both supported.

The Word length is 8 bits, with one or two stop bits and odd/even/no parity. The baud rate is also programmable to 300, 600, 1200, 2400, 4800, 9600, 19200 or 38400 baud.

## CONFIGURING MODBUS DEVICES

Points in Modbus devices connected to a Modbus-compatible **CBR** are mapped by the **CBR** to BACnet objects. This map is configured in the **Modbus** web page available on Modbus-compatible **CBRs**:

The screenshot shows the Modbus configuration web interface. The top panel is titled "Modbus Port Setup (Baud: 38400, Servicing Enabled)". It includes settings for Serial Port (Port 4), Drive (RS232), Response Timeout (100-9999 ms), Retries (0-9), Offline Re-Check Time (0-65535 s), and a checkbox for Modbus Servicing Enabled.

The bottom panel is titled "Modbus Device/Point Setup (2 of 48 devices, 217 of 1600 points in use)". It shows a list of devices and a detailed view of a device's points. The device is "001 HVAC Motor Control Panel" with BACnet ID 10001. The points table is as follows:

| ID | RD | Name                         | Reg. | Type           | Modbus Format | COV (write) | Scale (read) | Offset (read) | BACnet ID | Units             | Data   |
|----|----|------------------------------|------|----------------|---------------|-------------|--------------|---------------|-----------|-------------------|--------|
| 1  | ✓  | 01 BOILER 1 FLOW TEMP        | 1    | AO Holding Reg | float         | 0.1         | 1            | 0             | AI 1      | Degrees Celsius   | 73.504 |
| 2  | ✓  | 02 BOILER 1 RETURN TEMP      | 3    | AO Holding Reg | float         | 0.1         | 1            | 0             | AI 2      | Degrees Celsius   | 52.289 |
| 3  | ✓  | 03 BOILER 2 FLOW TEMP        | 5    | AO Holding Reg | float         | 0.1         | 1            | 0             | AI 3      | Degrees Celsius   | 22.564 |
| 4  | ✓  | 04 BOILER 2 RETURN TEMP      | 7    | AO Holding Reg | float         | 0.1         | 1            | 0             | AI 4      | Degrees Celsius   | 21.238 |
| 5  | ✓  | 05 UF HEATING FLOW TEMP      | 9    | AO Holding Reg | float         | 0.1         | 1            | 0             | AI 5      | No Units          | 19.322 |
| 6  | ✓  | 06 CANTEN SPACE TEMP         | 11   | AO Holding Reg | float         | 0.1         | 1            | 0             | AI 6      | Degrees Celsius   | 18.338 |
| 7  | ✓  | 07 EPS COMMS ROOM TRIP       | 519  | DI Input       | ✓             |             |              |               | BI 7      | Active / Inactive | 0      |
| 8  | ✓  | 08 COMMS ROOM TEMP           | 15   | AI Input Reg   | float         | 0.1         | 1            | 0             | AI 8      | Degrees Celsius   | 19.696 |
| 9  | ✓  | 09 BOILER 1 LOCKOUT          | 521  | DI Input       | ✓             |             |              |               | BI 9      | Active / Inactive | 0      |
| 10 | ✓  | 10 BOILER 2 LOCKOUT          | 522  | DI Input       | ✓             |             |              |               | BI 10     | Active / Inactive | 0      |
| 11 | ✓  | 11 HEATING PUMP A TRIP       | 523  | DI Input       | ✓             |             |              |               | BI 11     | Active / Inactive | 0      |
| 12 | ✓  | 12 HEATING PUMP B TRIP       | 524  | DI Input       | ✓             |             |              |               | BI 12     | Active / Inactive | 0      |
| 13 | ✓  | 14 SPARE                     | 525  | DI Input       | ✓             |             |              |               | BI 13     | Active / Inactive | 0      |
| 14 | ✓  | 15 SPARE                     | 526  | DI Input       | ✓             |             |              |               | BI 14     | Active / Inactive | 1      |
| 15 | ✓  | 15 UF HEATING HIGH LIMIT     | 527  | DI Input       | ✓             |             |              |               | BI 15     | Active / Inactive | 1      |
| 16 | ✓  | 16 UF HEATING PUMP TRIP      | 528  | DI Input       | ✓             |             |              |               | BI 16     | Active / Inactive | 0      |
| 17 | ✓  | 17 BOILER 1 ENABLE           | 635  | DO Coil        | ✓             |             |              |               | BO 17     | Active / Inactive | 1      |
| 18 | ✓  | 18 BOILER 2 ENABLE           | 636  | DO Coil        | ✓             |             |              |               | BO 18     | Active / Inactive | 0      |
| 19 | ✓  | 19 HEATING PUMP ENABLE       | 637  | DO Coil        | ✓             |             |              |               | BO 19     | Active / Inactive | 1      |
| 20 | ✓  | 20 HEATING PUMP DUTY         | 638  | DO Coil        | ✓             |             |              |               | BO 20     | Active / Inactive | 0      |
| 21 | ✓  | 21 EPS COMMS ROOM FAN ENABLE | 639  | DO Coil        | ✓             |             |              |               | BO 21     | Active / Inactive | 1      |
| 22 | ✓  | 22 BOILER 3 ENABLE           | 640  | DO Coil        | ✓             |             |              |               | BO 22     | Active / Inactive | 0      |
| 23 | ✓  | 23 UF HEATING PUMP ENABLE    | 641  | DO Coil        | ✓             |             |              |               | BO 23     | Active / Inactive | 0      |
| 24 | ✓  | 24 UF HEATING VALVE          | 285  | AO Holding Reg | float         | 0           | 1            | 0             | AO 24     | No Units          | 0.000  |

There are 2 panels on this page, each with a set of function buttons:



## MODBUS PORT SETTINGS

The top panel shows the setup of the CBR's Modbus port, and allows it to be edited:



## DEVICES AND POINT MAPPING

The bottom panel contains a list of attached Modbus devices, a sub-panel showing the setup of any selected device, and a table showing how Modbus Registers within that device are mapped to BACnet objects.

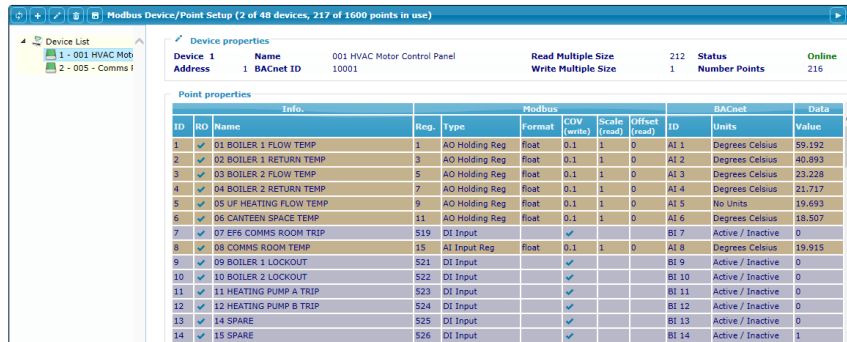

## Modbus Device Settings

When a device is selected in the list, its current settings are shown at the top of the panel:



To edit the device settings, first ensure that nothing is selected in the mapping table and then click on the edit button . This opens a dialog allowing Device Properties to be edited:

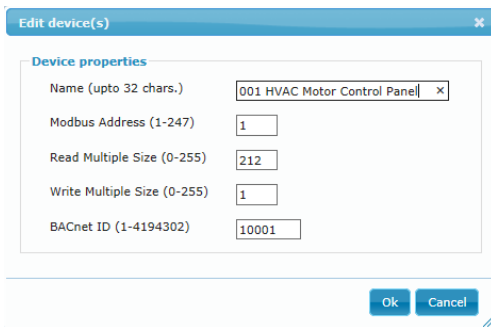

### The Modbus/BACnet mapping table

Below the device settings sub-panel there is a table that lists all of the Modbus Registers in the selected device that are to be accessed from BACnet, and for each one specifies the BACnet object to which it will be mapped.

| Info. |                                     |                         | Modbus |                |        |                                     | BACnet       |               | Data  |                   |        |
|-------|-------------------------------------|-------------------------|--------|----------------|--------|-------------------------------------|--------------|---------------|-------|-------------------|--------|
| ID    | RO                                  | Name                    | Reg.   | Type           | Format | COV (write)                         | Scale (read) | Offset (read) | ID    | Units             | Value  |
| 1     | <input checked="" type="checkbox"/> | 01 BOILER 1 FLOW TEMP   | 1      | AO Holding Reg | float  | 0.1                                 | 1            | 0             | AI 1  | Degrees Celsius   | 59.192 |
| 2     | <input checked="" type="checkbox"/> | 02 BOILER 1 RETURN TEMP | 3      | AO Holding Reg | float  | 0.1                                 | 1            | 0             | AI 2  | Degrees Celsius   | 40.893 |
| 3     | <input checked="" type="checkbox"/> | 03 BOILER 2 FLOW TEMP   | 5      | AO Holding Reg | float  | 0.1                                 | 1            | 0             | AI 3  | Degrees Celsius   | 23.228 |
| 4     | <input checked="" type="checkbox"/> | 04 BOILER 2 RETURN TEMP | 7      | AO Holding Reg | float  | 0.1                                 | 1            | 0             | AI 4  | Degrees Celsius   | 21.717 |
| 5     | <input checked="" type="checkbox"/> | 05 UF HEATING FLOW TEMP | 9      | AO Holding Reg | float  | 0.1                                 | 1            | 0             | AI 5  | No Units          | 19.693 |
| 6     | <input checked="" type="checkbox"/> | 06 CANTEEN SPACE TEMP   | 11     | AO Holding Reg | float  | 0.1                                 | 1            | 0             | AI 6  | Degrees Celsius   | 18.507 |
| 7     | <input checked="" type="checkbox"/> | 07 EF6 COMMS ROOM TRIP  | 519    | DI Input       |        | <input checked="" type="checkbox"/> |              |               | BI 7  | Active / Inactive | 0      |
| 8     | <input checked="" type="checkbox"/> | 08 COMMS ROOM TEMP      | 15     | AI Input Reg   | float  | 0.1                                 | 1            | 0             | AI 8  | Degrees Celsius   | 19.915 |
| 9     | <input checked="" type="checkbox"/> | 09 BOILER 1 LOCKOUT     | 521    | DI Input       |        | <input checked="" type="checkbox"/> |              |               | BI 9  | Active / Inactive | 0      |
| 10    | <input checked="" type="checkbox"/> | 10 BOILER 2 LOCKOUT     | 522    | DI Input       |        | <input checked="" type="checkbox"/> |              |               | BI 10 | Active / Inactive | 0      |
| 11    | <input checked="" type="checkbox"/> | 11 HEATING PUMP A TRIP  | 523    | DI Input       |        | <input checked="" type="checkbox"/> |              |               | BI 11 | Active / Inactive | 0      |
| 12    | <input checked="" type="checkbox"/> | 12 HEATING PUMP B TRIP  | 524    | DI Input       |        | <input checked="" type="checkbox"/> |              |               | BI 12 | Active / Inactive | 0      |
| 13    | <input checked="" type="checkbox"/> | 14 SPARE                | 525    | DI Input       |        | <input checked="" type="checkbox"/> |              |               | BI 13 | Active / Inactive | 0      |
| 14    | <input checked="" type="checkbox"/> | 15 SPARE                | 526    | DI Input       |        | <input checked="" type="checkbox"/> |              |               | BI 14 | Active / Inactive | 1      |

If a row in the register/object mapping table is selected, then clicking the edit button  will open a dialog allowing the mapping for that register to be edited. This dialog can also be opened by double-clicking on a row in the table.

The dialog has 4 tabs:

#### Info

This tab allows you to configure general information for a point. Enabling **Read Only** disables writing to the point via BACnet

#### Modbus

This tab allows you to configure Modbus Slave information for a point. This information is obtained from the Modbus Slave device datasheet.

When reading from the Modbus Slave point, the **Scaling** and **Offset** calculation will be applied before saving on the BACnet side. The **COV** parameter sets the amount by which the point's value must change as a result of BACnet writes, before the value is sent out by a Modbus Write.

## BACnet

The screenshot shows a window titled "Edit - Point ID 1" with a close button. Below the title bar are four tabs: "Info", "Modbus", "BACnet", and "Test". The "BACnet" tab is selected and highlighted in green. The main content area contains three fields: "Point Type" with a dropdown menu showing "AI", "BACnet ID" with a text input field containing "1", and "BACnet Unit" with a text input field containing "Degrees Celsius". A "Finish" button is located at the bottom right of the window.

This tab defines how the Modbus point will appear to the BACnet system.

## Test

The screenshot shows the same "Edit - Point ID 1" window, but with the "Test" tab selected and highlighted in green. The main content area contains three sections: "Value" with a text input field containing "62.524", "Operation" with two buttons labeled "Read" and "Write", and "Status" with a text area containing "point read ok". A "Finish" button is located at the bottom right of the window.

This tab is a simple dialog to allow you to test the communication link between the **CBR** and the Modbus Slave device.

### 3 BACnet Field Controllers

#### MAIN PLANT CONTROLLERS

The **CBM** (Cylon BACnet Main Plant) controllers are ideally suitable for main plant control, including AHUs, Boilers, Rooftop units, Lighting etc.

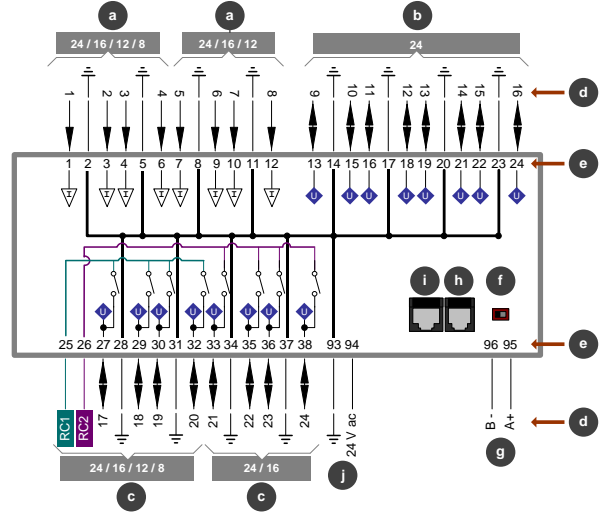
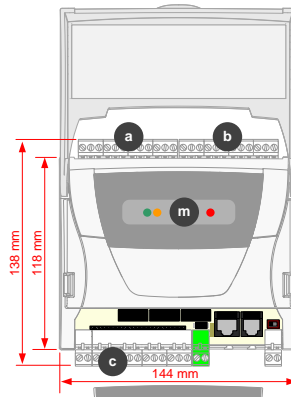





**CAUTION - DANGER OF EXPLOSION IF BATTERY IS INCORRECTLY REPLACED.**  
 REPLACE ONLY WITH THE SAME OR EQUIVALENT TYPE RECOMMENDED BY THE MANUFACTURER. DISPOSE OF USED BATTERIES ACCORDING TO THE MANUFACTURER'S INSTRUCTIONS.

|            |   |   |
|------------|---|---|
|            | a | Universal Input   |
|            | b | Uninput   |
|            | c | Uninput + Relay<br>• When these outputs are configured as 'relay' they use either terminal 25 <b>RC1</b> or terminal 26 <b>RC2</b> as their common point. Otherwise they use 28, 31, 34, or 37 ( $\perp$ ) as their common point. |
| <b>RC1</b> |   | Relay Common  |
| <b>RC2</b> |   | Relay Common  |
|            |   | Common  |
| <b>d</b>   |   | Point Numbers   |
| <b>e</b>   |   | Terminal Numbers  |

|   |   |
|---|---|
| <b>f</b>  | Fieldbus Terminator                                   |
|   | • OFF<br>(fieldbus not terminated at this controller) |
|   | • ON<br>(fieldbus terminated at this controller)      |
| <b>g</b>  | Fieldbus Port   |
| <b>h</b>  | External Keypad Port                                  |
| <b>i</b>  | Service Port  |
| <b>Note: Service Port must not be connected until after the device is powered on.</b> |   |
| <b>j</b>  | Power 24 V AC   |
| <b>m</b>  | Indicator LEDs  |

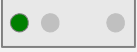

### CBM LED SIGNALS

|   |  |   |  |
|---|--|---|--|
|  | <p><b>Green LED</b><br/>                 Continuous: Strategy servicing and no comms.<br/>                 Flash rapidly (every 100 ms): Strategy not servicing.<br/>                 Flash once a second: MSTP comms, and Strategy servicing.<br/> <i>Note: when Service Port is in use, the Green LED blinks off as Service Port comms are received.</i></p> |  | <p><b>Cycle right to left (red - orange- green):</b><br/>                 Upgrade in progress while Controller is in terminal mode<br/> <i>Note: The strategy is not serviced while in upgrade mode.</i></p>   |
|  | <p><b>Orange LED</b><br/>                 Off: Normal operation.<br/>                 On: Priority Array set above 16, for one or more Hardware Points, by external BACnet Client or by CXpro<sup>HD</sup>.</p>  |  | <p><b>Cycle green to orange</b><br/>                 Globals communication/setup problem</p>   |
|   |  |  | <p><b>Green and orange flash simultaneously</b><br/>                 Globals communication/setup problem and Priority Array is set above 16 by external BACnet Client, or by the Cylon Engineering Center.</p> |

### UNITARY CONTROLLERS (CBT RANGE)

The Cylon BACnet Unitary Controller (CBT) is a BACnet Advanced Application Controller ideally suited to controlling single items of equipment.

#### CBT12iVAV / CBV-2U4-3T

The CBT12iVAV and CBV-2U4-3T variants have an integrated airflow sensor and actuator, and point support for single duct and fan assisted VAV applications.

**Note:** In the CBT12iVAV/CBV-2U4-3T, terminals 3, 18 and 33 are connected internally.

**Note:** Use caution when disconnecting the CBT-STAT connector. It is recommended that you press downwards with your finger at the end of the circuit board, beside the connector, while pulling the connector upwards.

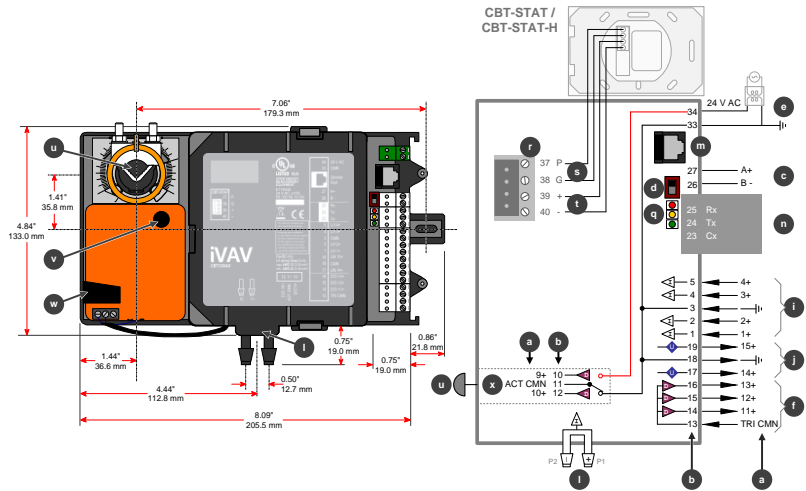

**CBT-4T4-4T**

**Note:** In the **CBT-4T4-4T**, terminals 12, 15, 17, 24, and 34 are connected internally. When a controller is powered, 24 V AC is available for low current devices at terminals 12, 15, 17, and 24. The total combined current must be less than 0.9 A.

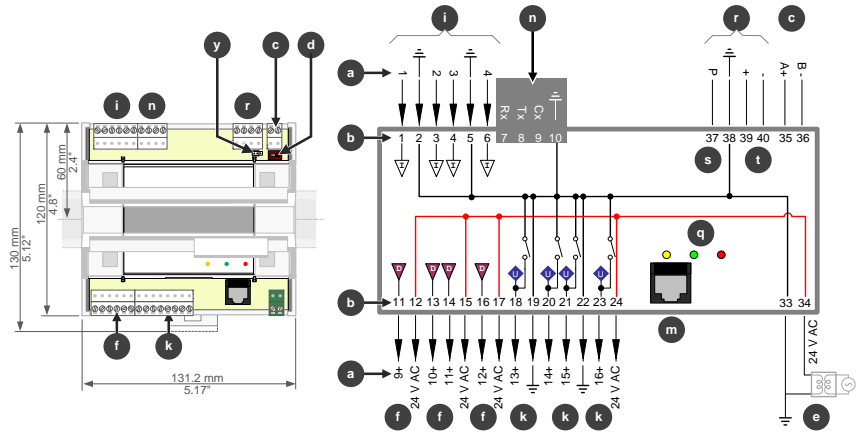

**CBT-3T6-5R**

The **CBT-3T6-5R** variant includes relays capable of switching mains voltage, and preconfigured strategies for Rooftop Unit and Heat Pump applications

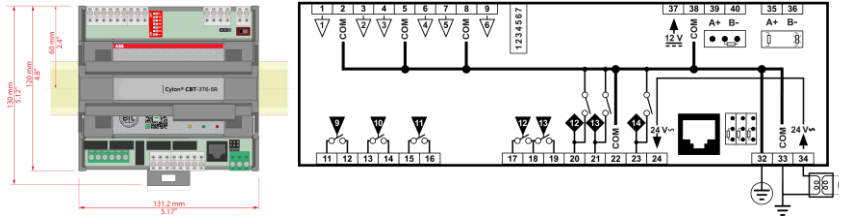

**Note:** CBT14 is intended for field installation within another enclosure.

**CBT-4T4-2U1R**

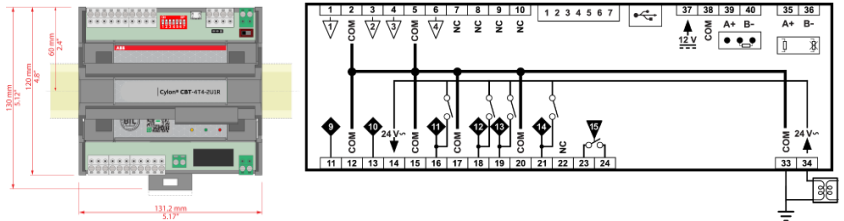

**CBT INDICATOR LED SIGNALS**

|   | CBT-4T4-4T<br>CBT-3T6-5R<br>CBT-4T4-2U1R | CBT12iVAV |
|---|--|-----------|
| <p><b>Red LED</b><br/>Continuous: Optional battery is healthy.<br/>Flash once a second: Indicates no battery/battery is low.</p> <p><b>Note:</b> Battery is present only on custom versions.</p> <p><b>CAUTION</b> - DANGER OF EXPLOSION IF BATTERY IS INCORRECTLY REPLACED. REPLACE ONLY WITH THE SAME OR EQUIVALENT TYPE RECOMMENDED BY THE MANUFACTURER. DISPOSE OF USED BATTERIES ACCORDING TO THE MANUFACTURER'S INSTRUCTIONS.</p> |  |           |
| <p><b>Green LED</b><br/>Continuous: Strategy servicing and no comms.<br/>Flash rapidly (every 100 ms): Strategy not servicing.<br/>Flash once a second: MSTP comms, and Strategy servicing.</p> <p><b>Note:</b> When Service Port is in use, the Green LED blinks off as Service Port comms are received.</p>   |  |           |
| <p><b>Yellow LED</b><br/>Off: Normal operation.<br/>On: Priority Array set above 16, for one or more Hardware Points, by external BACnet Client, or by the <b>Engineering Center/CXpro<sup>HD</sup></b></p>   |  |           |
| <p><b>Cycle left-to-right</b> (CBT-4T4-4T / CBT-3T6-5R / CBT-4T4-2U1R) or <b>top to bottom</b> (CBT12iVAV)<br/>Controller is in terminal mode.</p>  |  |           |
| <p><b>Cycle right-to-left</b> (CBT-4T4-4T / CBT-3T6-5R / CBT-4T4-2U1R) or <b>bottom to top</b> (CBT12iVAV)<br/>Upgrade in progress while Controller is in terminal mode.</p> <p><b>Note:</b> The strategy is not serviced while in upgrade mode.</p>  |  |           |
| <p><b>Cycle green to yellow</b><br/>Globals communication/setup problem</p>   |  |           |
| <p><b>Green and yellow flash simultaneously</b><br/>Globals communication/setup problem <b>and</b> Hardware Point Priority Array is set above 16 by external BACnet Client, or by the Engineering Centre.</p>   |  |           |

**CBT12IVAV, CBV-2U4-3T AND CBT-4T4-4T**

|          |   |  |   |
|----------|---|--|---|
|          | Common  | <b>m</b>   | Service Port (RJ-45)  |
| <b>a</b> | Point Numbers   | <b>Note:</b> Service Port must not be connected until after the device is powered on.  |   |
| <b>b</b> | Terminal Numbers  | <b>n</b>   | Service Port (screw terminal)   |
| <b>c</b> | BACnet MS/TP Port<br><b>Important:</b> In order for the BACnet MS/TP bus to operate reliably, the common power connection (terminal 33 $\oplus$ ) must be connected to Earth. It is recommended that this is done at the 24 V AC transformer. | <b>Note:</b> Service Port must not be connected until after the device is powered on.  |   |
| <b>d</b> | BACnet MS/TP Terminator   | <b>o</b>   | 7-way DIP switch. Setting this to an address between 1 and 127 and cycling the power will force the controller to update its MAC address to match the DIP settings. |
|          | <ul style="list-style-type: none"> <li>• OFF (BACnet MS/TP bus not terminated at this controller)</li> <li>• ON (BACnet MS/TP bus terminated at this controller)</li> </ul>   | <b>Note:</b> Failure to subsequently return the switch to all zeros will render the unit unable to be configured electronically or remotely. |   |
| <b>e</b> | Power 24 V AC<br><b>Important:</b> The common power connection (terminal 33 $\oplus$ ) must be connected to Earth. It is recommended that this is done at the 24 V AC transformer.  | <b>p</b>   | UniPut current sink enable jumpers  |
|          | <b>WARNING</b><br>CBT14 UNIT MUST BE EARTHED  |  | Sink disabled   |
| <b>f</b> | Digital Outputs   |  | Sink enabled  |
| <b>g</b> | Relay digital outputs (24 V AC)   | <b>q</b>   | Indicator LEDs see <i>CBT Indicator LED Signals</i> on page 27)   |
| <b>i</b> | Universal Input   | <b>r</b>   | Room Display / CBT-STAT Port  |
| <b>j</b> | UniPut  | <b>s</b>   | Room Display / CBT-STAT Power supply  |
| <b>k</b> | UniPuts + Triac   | <b>t</b>   | Room Display / CBT-STAT RS485   |
| <b>l</b> | Airflow Sensor  | <b>u</b>   | Rotary Actuator   |
|          |   | <b>v</b>   | Actuator direction selector   |
|          |   | <b>w</b>   | Damper Manual Override  |
|          |   | <b>x</b>   | Internal Actuator Outputs   |
|          |   | <b>y</b>   | Room Display / CBT-STAT Terminator  |
|          |   |  | OFF (Not Terminated)  |
|          |   |  | ON (Terminated)   |

**CBT-3T6-5R**

| Location | Illustration | Terminal Numbers | Description  |
|----------|--------------|------------------|--|
|          |              | 35, 36           | <p>BACnet MS/TP Port</p> <p><b>Important:</b> In order for the BACnet MS/TP bus to operate reliably, the common power connection (terminal 33 <math>\frac{\ominus}{\oplus}</math>) must be connected to Earth. Cylon recommend that this is done at the 24 V AC transformer.</p> |
|          |              |                  | <p>BACnet MS/TP Terminator</p> <p>The Modbus Terminator Switch is located below the port. If the switch is towards the <math>\uparrow</math> icon, then termination is <i>in</i> and if the switch is towards the <math>\times</math> icon then termination is <i>out</i>.</p>   |
|          |              | 32 ... 34        | <p>Power 24 V AC</p> <p><b>Important:</b> The common power connection (terminal 33 <math>\frac{\ominus}{\oplus}</math>) must be connected to Earth. Cylon recommend that this is done at the 24 V AC transformer.</p> <p><b>Note:</b> THIS UNIT MUST BE GROUNDED</p>             |
|          |              | 20 ... 23        | UniPuts with Triac   |
|          |              |                  | <p>UniPut current sink enable jumpers</p> <p> Sink disabled</p> <p> Sink enabled</p>   |
|          |              | 1 ... 9          | Universal Inputs   |
|          |              | 24               | 24 V AC output   |
|          |              | 11 ... 16        | <p>Relay digital outputs 240 V AC, 2 (1) A<br/>(USA: Pilot Duty 120 V AC, 72 VA)</p> <p><b>WARNING:</b> HAZARDOUS VOLTAGES.<br/>DISCONNECT SUPPLY TO MAINS RELAYS AND 24 V AC TO UNIT BEFORE WIRING.</p>   |
|          |              | 17 ... 19        | Relay digital outputs (24 V AC)  |
|          |              |                  | <p>Service Port (RJ45)</p> <p><b>Note:</b> Service Port must not be connected until after the device is powered on.</p>  |
|          |              |                  | Indicator LEDs   |
|          |              | 37 ... 40        | Keypad Port  |
|          |              | 37, 38           | Room Display / CBT-STAT Power supply   |
|          |              | 39, 40           | Room Display / CBT-STAT RS485  |
|          |              |                  | <p>Room Display / CBT-STAT Terminator</p> <p> OFF (Not Terminated)</p> <p> ON (Terminated)</p>   |

**CBT-4T4-2U1R**

| Location | Illustration | Terminal Numbers | Description  |
|----------|--------------|------------------|--|
|          |              | 35, 36           | BACnet MS/TP Port<br><b>Important:</b> In order for the BACnet MS/TP bus to operate reliably, the common power connection (terminal 33 $\perp$ ) must be connected to Earth. Cylon recommend that this is done at the 24 V AC transformer. |
|          |              |                  | BACnet MS/TP Terminator<br>The Modbus Terminator Switch is located below the port. If the switch is towards the $\perp$ icon, then termination is in and if the switch is towards the $\perp$ icon then termination is out.                |
|          |              | 33, 34           | Power 24 V AC<br><b>Important:</b> The common power connection (terminal 33 $\perp$ ) must be connected to Earth. Cylon recommend that this is done at the 24 V AC transformer.  |
|          |              | 16 ... 21        | UniPuts with Triac   |
|          |              | 1 ... 6          | Universal Inputs   |
|          |              | 11, 13           | UniPuts  |
|          |              | 14               | 24 V AC output   |
|          |              | 23,24            | Relay digital output 240 V AC,<br>Maximum Load: 240 V AC / 8 A Max<br><b>WARNING:</b> HAZARDOUS VOLTAGES.<br>DISCONNECT SUPPLY TO MAINS RELAYS AND 24 V AC TO UNIT BEFORE WIRING.  |
|          |              |                  | Service Port (micro-USB)<br><b>Note:</b> Service Port must not be connected until after the device is powered on.  |
|          |              |                  | Indicator LEDs   |
|          |              | 37 ... 40        | Keypad Port  |
|          |              | 37, 38           | Room Display / CBT-STAT Power supply   |
|          |              | 39, 40           | Room Display / CBT-STAT RS485  |
|          |              |                  | Room Display / CBT-STAT Terminator<br>OFF (Not Terminated)<br>ON (Terminated)  |

## CBX-8R8 AND FLX-8R8

### DIMENSIONS

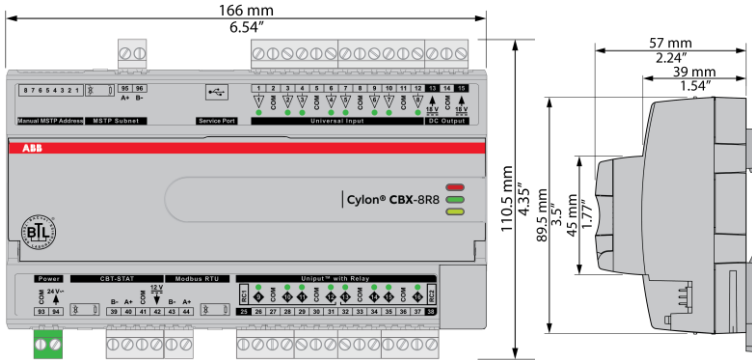

### WIRING

#### CBX-8R8

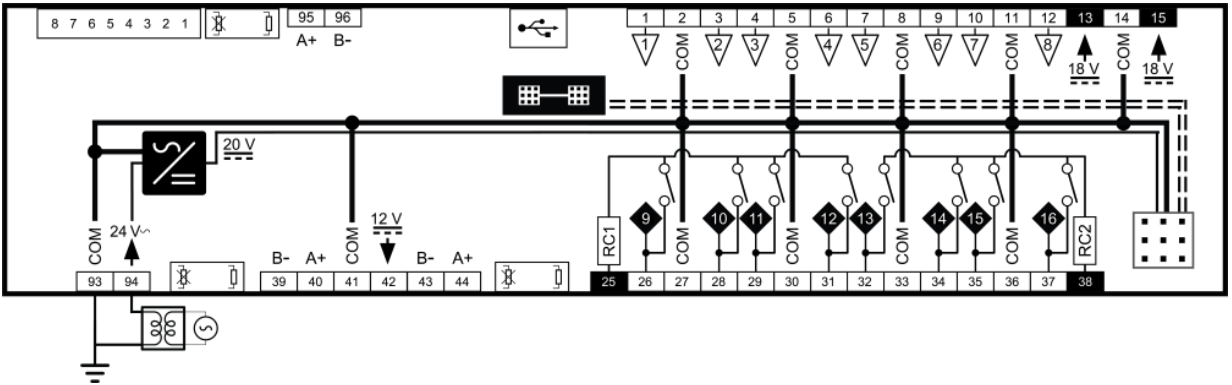



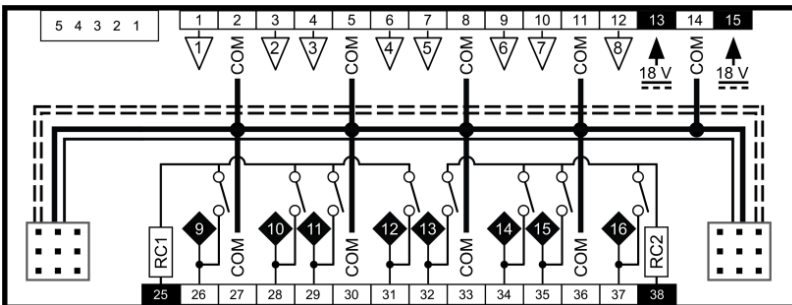



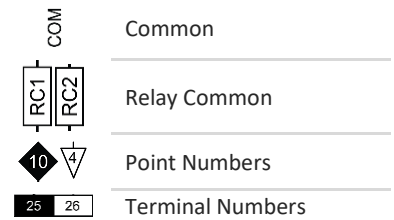



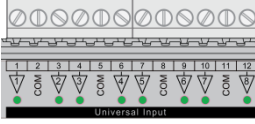

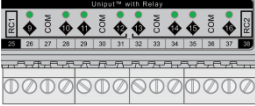



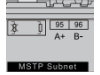

#### FLX-8R8 and FLX-8R8H

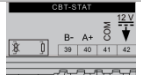

**CAUTION** - DANGER OF EXPLOSION IF BATTERY IS INCORRECTLY REPLACED.  
 REPLACE ONLY WITH THE SAME OR EQUIVALENT TYPE RECOMMENDED BY THE MANUFACTURER. DISPOSE OF USED BATTERIES ACCORDING TO THE MANUFACTURER'S INSTRUCTIONS.

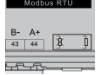

**TERMINALS**









| Location  | Illustration  | Terminal Numbers | Description  |
|---|---|------------------|--|
|    |    | 1 ... 12         | <p>Universal Inputs</p> <p>When input is configured as <b>Digital</b>:</p> <ul style="list-style-type: none"> <li>LED <b>Off</b>: open circuit or logic 'off'</li> <li>LED <b>On</b>: logic 'on'</li> </ul> <p>When input is configured as <b>Resistor/thermistor</b>:</p> <ul style="list-style-type: none"> <li>LED <b>Off</b>: valid resistance connected (<b>Note</b>: 0 Ω is counted as valid)</li> <li>LED <b>Slow blink</b>: resistor/thermistor not connected</li> </ul> <p>When input is configured as <b>Analog</b>:</p> <ul style="list-style-type: none"> <li>LED intensity is modulated by the analog signal</li> </ul> <p>When the LED is blinking:</p> <ul style="list-style-type: none"> <li><b>Fast blink</b> indicates error condition</li> <li><b>Two short flashes followed by a value*</b> indicates the input is in an override state (overridden by Engineering Center).</li> </ul> |
|   |    | 25 ... 38        | <p>UniPuts + Relay</p> <p>When a Uniput channel is configured as an input, the LED signals are identical to Universal Inputs above. When configured as an output the following apply:</p> <p>When output is configured as <b>Digital</b>:</p> <ul style="list-style-type: none"> <li>LED <b>Off</b>: open circuit or logic 'off'</li> <li>LED <b>On</b>: logic 'on'</li> </ul> <p>When output is configured as <b>Analog</b>:</p> <ul style="list-style-type: none"> <li>LED intensity is modulated by the analog signal</li> </ul> <p>When the LED is blinking:</p> <ul style="list-style-type: none"> <li><b>Fast blink</b> indicates error condition</li> <li><b>Two short flashes followed by a value</b> indicates the output is in an override state (overridden by <b>Engineering Center</b> or HOA).</li> </ul>  |
|  |  | 93, 94           | 24 V AC Power  |
|  |  | 13 ... 15        | Auxiliary Power: 18 V DC output on 2 terminals, 60 mA total  |
|  |  | 95, 96           | <p>MS/TP Port (RS-485) screw terminal</p> <p>MS/TP subnet terminator switch is located beside the port. If the switch is towards the  icon, then termination is in and if the switch is towards the  icon then termination is out.</p>   |
|  |  | 39 ... 42        | <p>UCU Room Display / CBT-STAT Port</p> <p>The CBT-STAT bus Terminator Switch is located beside the port. If the switch is towards the  icon, then termination is in and if the switch is towards the  icon then termination is out.</p>   |
|  |  | 43, 44           | <p>Modbus RTU [future option]</p> <p>The Modbus Terminator Switch is located beside the port. If the switch is towards the  icon, then termination is in and if the switch is towards the  icon then termination is out.</p>   |

**\*Note:** The LED intensity illustrates the value measured at the input terminals. The flash indicates that this value has been overridden.



| Location | Illustration | Description  |
|----------|--------------|--|
|          |              | Service Port (Micro USB)   |
|          |              | <p>8-way MS/TP address DIP switch (CBX only)</p> <p>The controller's BACnet MAC address can be set either electronically (USB or BACnet) or manually using the 8-way DIP switch.</p> <ol style="list-style-type: none"> <li>1) <b>Manual setting for ease of replacement:</b> Setting the 8-way DIP switch to an address between 1 and 254, and then cycling the power, will force the controller to update its MAC address to match the DIP settings. To replace a manually-addressed controller in the field simply copy the DIP switch setting of the controller you are replacing.</li> <li>2) <b>Electronic setting for remote configuration:</b> Setting the 8-way DIP switch to all zeros will allow the MAC address to be set electronically either locally by USB or remotely over BACnet.</li> </ol> <p>It is also possible to use manual setting for initial commissioning, and then cycling the power to force the controller to update its MAC address to match the DIP settings. To enable subsequent electronic configuration, set the DIP switch to all zeros. The controller will retain the manually-set address until it is electronically overwritten.</p> |
|          |              | <p>5-Way FLX bus address DIP switch (FLX only).</p> <p>This sets the address of the FLX unit on its local FLX bus.</p>   |
|          |              | <p>Output Override (CBX-8R8-H and FLX-8R8-H only)</p> <p><b>Bottom position:</b> Off - outputs forced off.</p> <p><b>Centre position:</b> Auto - outputs are controlled by strategy.</p> <p><b>Top position:</b> Manual – for digital outputs, the output is forced on. For analog outputs the knob setting controls the output value.</p> <p style="background-color: #e0e0e0; padding: 5px;">Note: Manual position is supervised, i.e. the strategy is aware of the manual value.</p>  |
|          |              | Inter-module connection sockets  |
|          |              | Inter-module connector   |
|          |              | FLX bus terminator   |
|          |              | <p>Indicator LEDs</p> <p>(for Indicator LED signals, see <i>CBX and FLX Indicator LED Signals</i> on page 34)</p>  |

**CBX AND FLX INDICATOR LED SIGNALS**

|   | Off                          | On                   | Slow Blink                                  | Fast blink  |                     |
|---|------------------------------|----------------------|---|---|---------------------|
| <br><br> | <b>Red LED</b><br>(Power)    | Power is off         | Power is on                                 | — Unit Rebooting —                                  |                     |
| <br><br> | <b>Green LED</b><br>(Status) | Unit is not running  | Strategy Loaded but no network connectivity | Strategy Loaded and device communicating on network | No Strategy loaded  |
| <br><br> | <b>Yellow LED</b><br>(FLX)   | FLX bus comms are ok | No FLX bus comms                            | FLX bus address clash                               | FLX bus comms error |

During firmware upgrade the Yellow LED will remain on while the strategy/comms section reboots, and then the LEDs will rotate Red-Green-Yellow while the IO section reboots.

**Note:** During typical operation, the Red LED should be on, the Green LED should be blinking and the Yellow LED should be off.



## POWER SUPPLY UNIT: FLX-PS24

The **FLX-PS24** power supply module is designed to deliver reliable and consistent output power to the **FLX** I/O modules, and allow the **CBXi** trunk to be expanded beyond 64 I/O points to a maximum of 96 I/O points:

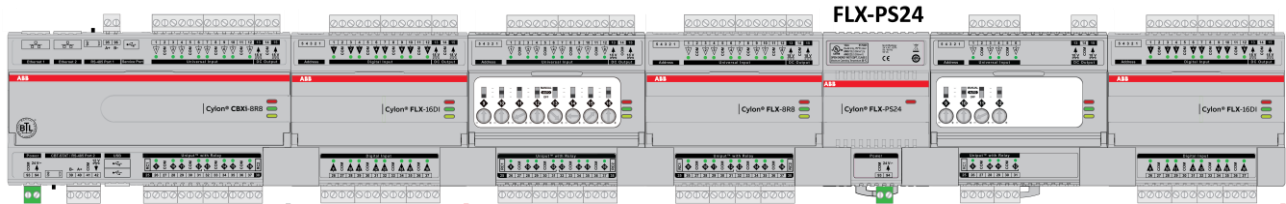

Additionally, the **FLX-PS24** can be used to extend the distance between the remote mounting of **FLX** I/O modules and Cylon's **CBX** or **CBXi** BACnet® field controllers. **FLX-PS24** facilitates remote connection of **FLX** modules to **CBX** or **CBXi** to a maximum overall length of 1200 m (3280 ft). Each **FLX-PS24** can power a bus segment of up to 30 m (100 ft):

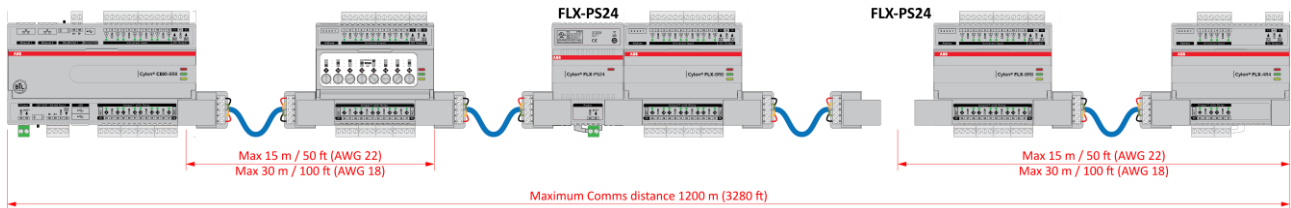

The power supply module can also be used to power field devices that require DC power when connected to the **CBX** and **CBXi** controllers by providing 20 V DC DIN rail-mounted power supply for external field devices using the **FLX-RMC**:

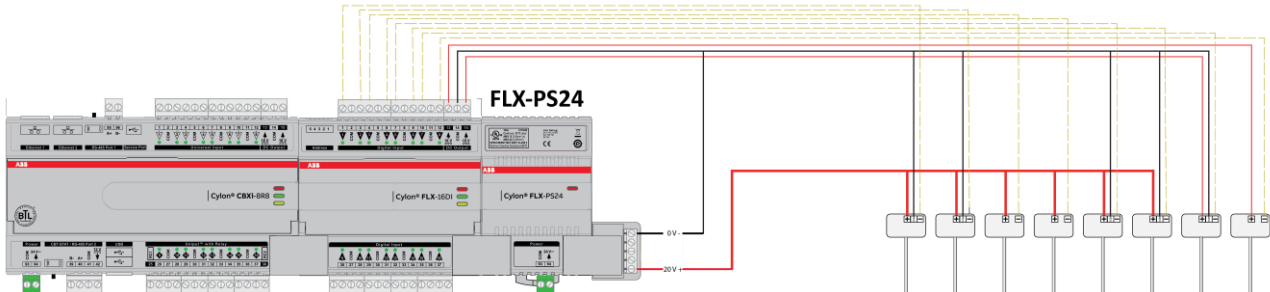

**DIMENSIONS AND WIRING:**

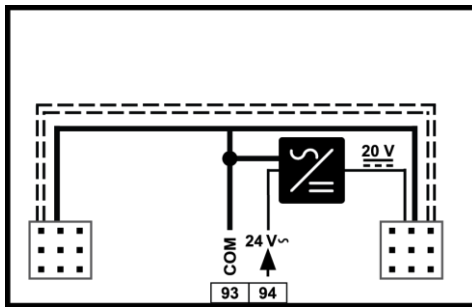
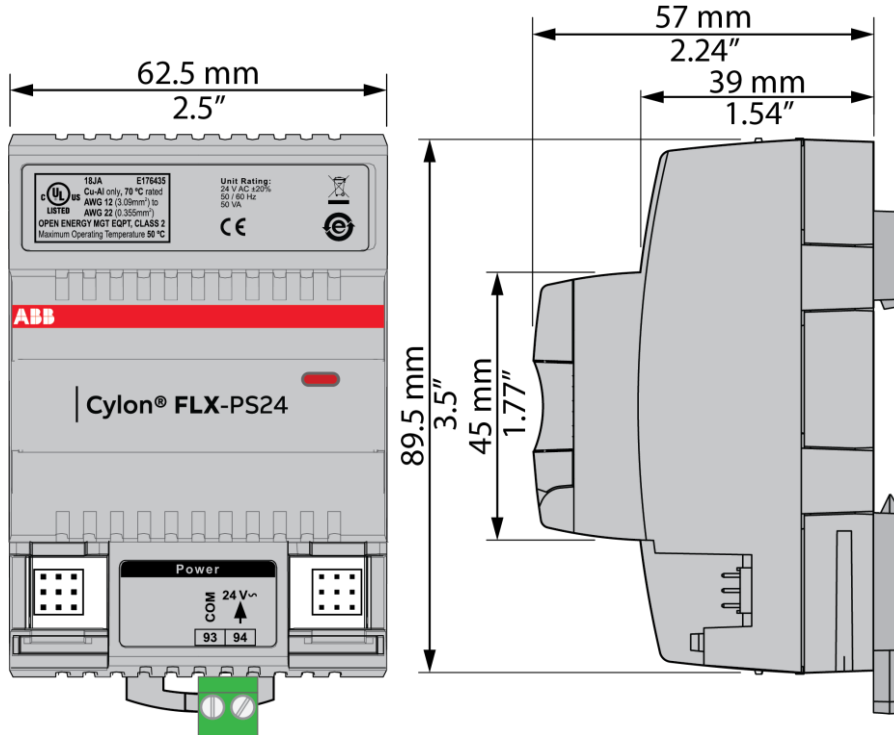

|  | Terminal Numbers | Description                     |
|--|------------------|---------------------------------|
|  | 93, 94           | 24 V AC Power                   |
|  | NA               | Inter-module connection sockets |
|  | NA               | Inter-module connector          |

## 4 Installation

### WIRING NOTES

#### Main Plant Controllers (CBM & CBX)

**CBM** and **CBX** outputs that are configured as relay outputs must use either terminal 25 (RLY CMN 1) or terminal 26 (RLY CMN2) as their common point.

All other **CBM** and **CBX** output configurations must use 28, 31, 34, or 37 (CMN) as their common point.

#### Unitary Controllers (CBT)

On **CBT** controllers, terminals 12, 15, 17, 24, and 34 are connected internally. When a controller is powered, 24 V AC is available for low current devices at terminals 12, 15, 17, and 24. The total combined current must be less than 0.9 A.

#### IMPORTANT

Earth all **CBT** controllers by connecting the CMN wire (Go) on the secondary side of the 24 V AC transformer to Earth at one point.

**Note:** **CBT** controllers do not have battery-backed memory. With Firmware version 7.5.8J or earlier, when a setpoint is changed from a B-OWS it will be written to flash on a 10-minute cycle, so that if the controller is power-cycled before that happens the setpoint value will be lost.

**Note:** Because **CBT** controllers do not have battery-backed memory, when a Strategy is downloaded to the controller it will be written to Flash memory after a period of about 14 seconds. While writing, the controller will be unresponsive for several seconds. If the controller is power-cycled before this write happens, the downloaded Strategy will be lost.

## HOW TO CONNECT CBM AND CBT FIELD CONTROLLERS

### CONNECTING 24 V AC POWER SUPPLY

The terminal labeled "GND" connects to the secondary of the 24 V AC isolation transformer. This wire (G<sub>0</sub>) must be connected to mains earth at the transformer. The diagram here illustrates the correct connection of a **CBM** to the 24 V AC supply.

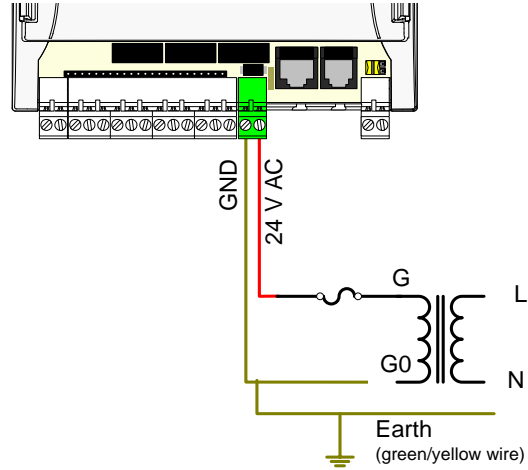

The terminal labeled "24 V AC" connects to the other wire of the 24 V AC isolation transformer secondary, usually via an external fuse. In calculating the rating for this external fuse, refer to the controller datasheet for the VA of the specific controller.

### Power Terminal test

When setting up a power supply, the following power terminal test must be carried out when the first CBM/CBT controller is connected to it. This test requires the use of an AC voltmeter.

1. Switch voltmeter to > 250 V AC range.
2. Apply power to mains transformer.
3. Check voltage and polarity **before** connecting to **CBM** or **CBT** controller.

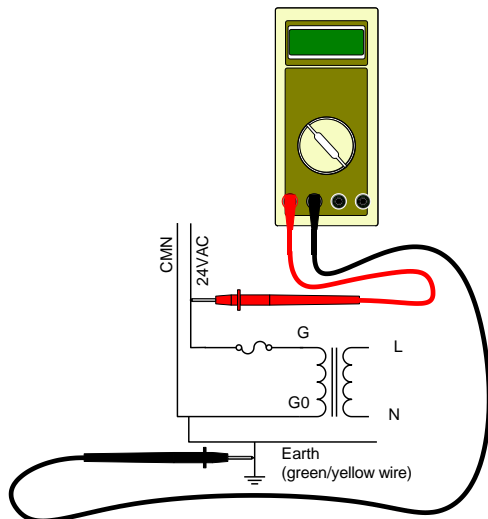

4. Apply power to the **CBM**, **CBX** or **CBT** controller via the mains transformer.
5. Measure the voltage between the labeled 24 V AC and mains earth. If this reading is not 24 V AC +/- 20%, there is a wiring fault.

**CONNECTING NETWORK BUS****Warning:**

Although the fieldbus is protected from high voltages, it is advisable to check the cabling.

The recommended network cable is Belden 9841 for maximum line length and Belden 8132 for distances of less than 500 m.

**Note:** The RS485 standard, on which the MS/TP fieldbus is based, allows a maximum line length of 1.2 km (4000 ft). Distances greater than this cannot be guaranteed for reliable operation.

A segment of cable is a length of cable running between two consecutive field controllers. The shield on each segment of cable should be grounded with a short stub at one point only.

**Note:** The grounding point for the shield should be as close as possible to terminals A and B.

The twisted pair consists of two wires with different colors. Assign one color to terminal A, and the other color to terminal B.

**Note:** Keep the same wiring color code assignment for all **Cylon BACnet** controllers on the fieldbus. Failure to follow this procedure will make it much more difficult to subsequently trace any wiring faults.

The ground stub length of the twisted pair should be close to zero. The maximum length is 250mm.

Strain relief should be provided on the fieldbus cables so that no force can be applied to terminals A and B by cable movements.

The RS485 fieldbus requires a terminating resistor at each end of the fieldbus.

- If a **CBR** is at the beginning of the fieldbus, the first terminating resistor is on the **CBR**, and is in/out selectable with the terminator switch. The other terminating resistor should be installed at the end of the network, i.e. between terminals A and B of the last Field Controller (**CBM** or **CBT**). This resistor is in/out selectable using the terminator switch on the **CBM** or **CBT**.
- If there is a Field Controller (**CBM** or **CBT**) on each end of the fieldbus and the **CBR** is in the middle, the terminating resistor will be installed on the first and last Field Controllers between terminals A and B. This resistor is in/out selectable using the terminator switch on the **CBM** or **CBT**.

Ferrules are suggested for connection of the network wires to terminals A and B (e.g. Weidmuller 0.75mm ferrule and Weidmuller PZ4 Crimp tool).

**Note:** The RS485 fieldbus for all **Cylon BACnet** controllers must be

- wired with Belden 9841 or equivalent cable.
- wired in a daisy chain topology (as with Cylon's **Unitron** fieldbus or with a Modbus RS485 fieldbus).
- terminated with a 120 Ohm resistor which is built into our controllers at the start and at the end of the network.

Failing any of these requirements will lead to intermittent and permanent loss of communications with devices, and also a slower network.

## CONNECTING INPUT PORTS

Each input port consists of 2 contact points, one for input signal and the other for the corresponding ground. Each ground (CMN) terminal is shared between two input signals.

The sensor cable should be AWG 20 minimum gauge (3.3  $\Omega$  per 100 m approx.) twisted pair shielded cable, e.g. Belden 8760 or 8762 2-core cable.

The sensor cable shield should be grounded at one point, close to the input port of the Field controller. There should be a screw and nut or alternative arrangement located there to accept this shield.



### **WHAT IS THE RECOMMENDED WAY TO CONNECT GROUND WIRES FROM SENSORS AND ACTUATORS TO THE CBM I/O TERMINALS?**

There are two I/O terminals for every one Return/Ground terminal in a Main Plant Controller. For best accuracy in signal measurement you must not share Return/Ground wires between equipment i.e. Each piece of equipment should have its own Return/Ground wire going back to the Main Plant Controller Terminals.

Do not share Ground wires between Outputs and Inputs.

**Note:** the use of ferrules is recommended for connecting wires to the screw-terminals. As a result, in most cases each ferrule used for Ground connections will have two wires crimped into it.



## CONNECTING UNIPUT PORTS

The 2 x RLY CMN terminals normally should be connected to Ground/G<sub>0</sub>. They should be wired directly back to the Ground side of the transformer secondary. Because of the high switch currents coming from the Relay Common terminals it is recommended not to share these return wires with other equipment. The loads are then connected directly to 24 V AC.

It is possible to connect 24 V AC to the Relay Common terminals and 'Ground' the loads but this requires careful attention to wiring and the Strategy to ensure 24 V AC is not accidentally switched out to any 0 – 10 V actuators that may be used.

It is recommended for normal applications to keep Inputs on Points 1 to 16 and outputs on points 17 to 24 where possible in case of wiring or Strategy errors.

When using the Output Points 17 to 24 as 0 ... 10 V outputs, then the Return terminals are the CMN terminals which are internally connected to G<sub>0</sub> (GND/CMN) in the Main Plant Controller (not the RLY CMN terminals, which are isolated from GND).



### INTO WHICH MODE SHOULD UNIPUTS BE CONFIGURED FOR DETECTING 24 V AC?

To detect the presence or absence of 24 V AC on an input you should normally select Active Digital Input (0...10 V) mode. Connect the UniPut Extract module to the Digital Input Hardware Point to access the 24 V AC status.

Only use Digital Passive (Volt-Free) mode for 24 V AC detection when you specifically need to distinguish between open and short circuit input states e.g. detect when a 24 V AC bulb has gone open circuit.



### WHAT HAPPENS IF I CONNECT 24 V AC INTO AN OUTPUT?

All I/O in the Main Plant Controller range in all modes of operation are protected against voltages up to 24 V AC. However when UniPuts are configured into relay mode care must be taken in the wiring of the controller to ensure that relay contacts do not short 24 V AC to GND as the resulting high currents could damage the controller.

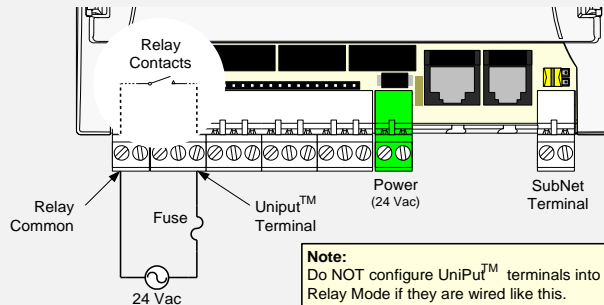

### HOW ARE HARDWARE POINTS 1 TO 24 CONFIGURED IN MAIN PLANT CONTROLLERS?

In the factory all Universal Inputs and UniPut I/O terminals are configured in a "Safe Input" mode. In this safe mode, Zero Volts appears on the terminals, all relay contacts are open and 24 V AC can safely be applied to any Hardware Point. This is how the terminals will appear when the controller is first powered up.

The Main Plant Controller terminals also go into this safe mode when the Strategy is wiped or when the setup block is set to zero (i.e. Strategy is not running).

## HOW TO CONNECT CBX CONTROLLERS

### APPLY POWER TO THE CBX-8R8(-H)

#### Set the CBX MS/TP Address

To communicate to other MS/TP devices on a BACnet® MS/TP network, the MS/TP address must be set to a unique address within the MS/TP subnet. Where possible, there should be no gaps between addresses. The BACnet® Instance Number must also be unique for the BACnet® site.

The 8-way DIP switch can be used to set the MS/TP address when the device is first powered on.

- The address is set in binary, from 1 (0000001) to 127 (1111111).
- A switch moved to the center (towards the 'ON' mark) represents 1, moved to the edge represents 0.
- The right-most switch (labeled "1") is the least-significant bit; the switch on the left (labeled "8") is the most-significant bit.

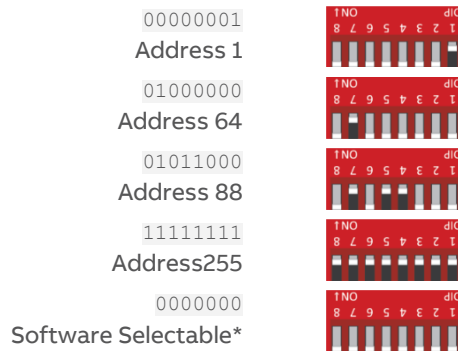

**\*Note:** If it is required that the CBX-8R8(-H)'s address can be configured remotely via BACnet® or electronically via USB, then once the CBX-8R8(-H) has been powered up (*Installation step 0*) the 8-way DIP switch should be set to all zeros.

Setting the 8-way DIP switch to all zeros will allow the MAC address to be set electronically either locally by USB or remotely over BACnet®.

It is also possible to use manual setting for initial commissioning, and then cycling the power to force the controller to update its MAC address to match the DIP settings. To enable subsequent electronic configuration, set the DIP switch to all zeros. The controller will retain the manually-set address until it is electronically overwritten.

**Note:** If no address had previously been set (e.g. when the device is received from the factory), then a device that is powered-on with the DIP switch set to all zeros will use the last 2 digits of its serial number as its initial address.

The MS/TP baud rate must match on all devices on the MS/TP subnet.

### Connect 24 V AC Power to the CBX-8R8(-H)

For the initial configuration of the device, the controller must first be powered on.

**Note:** Service Port (USB connection) must not be connected until after the device is powered on.

The **CBX-8R8(-H)** requires 24 V AC supplied from an externally mounted power transformer. One conductor of the transformer must be grounded to an earth ground to avoid damage to the controller. This conductor will be wired to the **COM** (common) terminal of the controller. The wiring diagram is shown here:

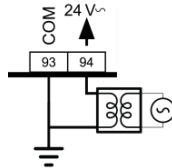

**Note:** Ensure the 24 V AC and Common wires are correctly connected to the controller. If the wires are swapped, it may cause damage to anything connected to the controller.

## CONNECT THE CBX TO THE MS/TP NETWORK

Attach RS-485 communication wires to the MS/TP Subnet port

Wiring the RS-485 network involves connecting the **A+** (95) and **B-** (96) terminals in a daisy-chained configuration. One end of the network will be connected to the Fieldbus of the Network-level controller or BACnet® router. At the other end of the network, the last device must be “terminated” by either installing a 100 Ω ... 120 Ω resistor or, if the last device is a **CBX**, users can switch the MS/TP Subnet terminator switch (located beside the MS/TP port) towards the  icon. This will effectively terminate the network. The shield (screen) must be carried through the entire network.

If the RS-485 network is wired to an **eSC**, then the shield will be grounded at the **eSC**.

If the RS-485 network is wired to a **CBR**, the shield must be grounded at one point on the network as shown below:

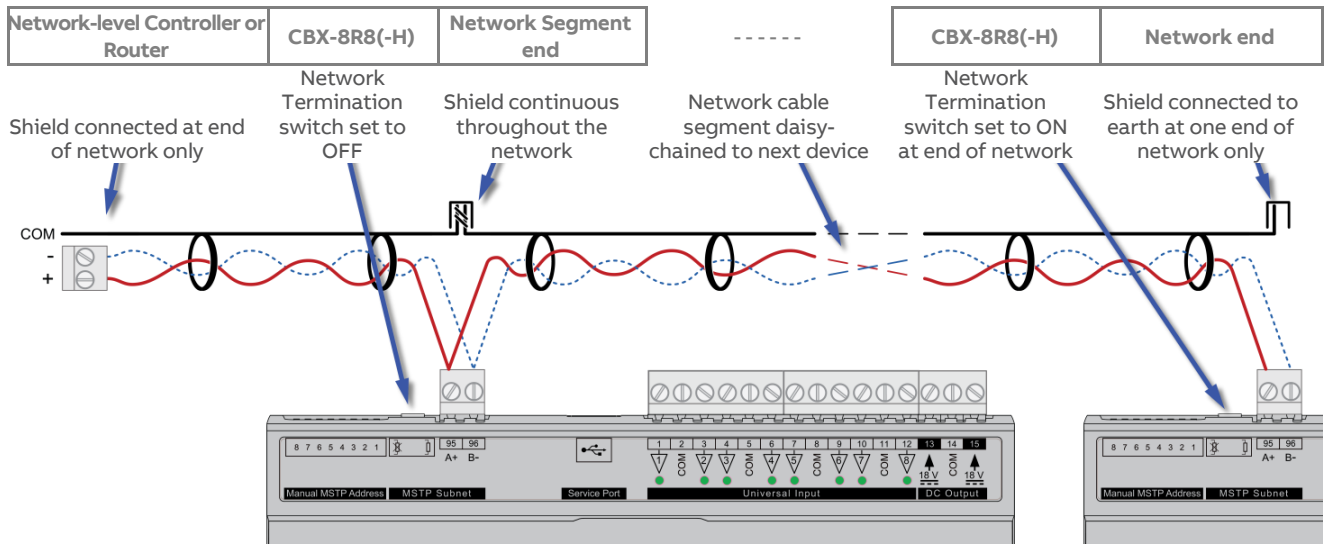

### Terminate the MS/TP network

If the **CBX-8R8(-H)** is the last device on the RS-485 network, then its MS/TP subnet terminator switch must be set to “”

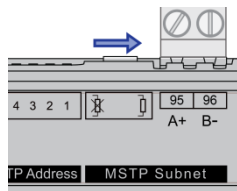

## CONFIGURE THE CBX-8R8(-H) FOR BACNET® COMMUNICATIONS

### CBX-8R8(-H) Default Settings

The **CBX-8R8(-H)** is shipped with the following default settings:

|                          |  |
|--------------------------|--|
| MS/TP Address:           | last 2 digits of the numeric portion of the serial number* |
| BACnet® Instance Number: | entire numeric portion of the Controller's serial number*  |
| MS/TP Baud Rate:         | 38,400 bps   |

**\*Note** CBX serial numbers are structured as “CCBX” followed by a sequential number followed by a letter: CCBX (numeric portion) (letter)

**Note** If the ‘numeric portion’ of the Controller serial number ends with ‘00’ then the MS/TP address is set to 100 rather than 0 to avoid conflict with the CBR default MS/TP address.

e.g. If the Controller serial number is CCBX727458C, the ‘numeric portion’ is 727458. In that case the MS/TP address would be 58 and the BACnet Instance Number would be 727458.

If the Controller serial number is CCBX812300C, the ‘numeric portion’ is 812300. In that case the MS/TP address would be 100 and the BACnet Instance Number would be 812300.

### Connect CXpro<sup>HD</sup> to the CBX-8R8(-H)

Connect the laptop to the **CBX-8R8(-H)** through a BACnet® Router such as **CBR** or **ASPECT® Control Engine (ACE - Matrix or Nexus Series)** via Ethernet, or directly using a standard Micro-B USB cable.

**Note:** When the **CXpro<sup>HD</sup>** PC is connected to the **CBX** USB port for the first time, you will be prompted to install a driver. Install “STMicroelectronics Virtual COM port”, and then select the corresponding serial port in **CXpro<sup>HD</sup>** to connect to the **CBX**. If you are using Windows 8.1 this driver may not be available by default, please contact Cylon TSG for a copy of the driver.

Once connected to the controller, it is possible to change the settings on the controller using **CXpro<sup>HD</sup>** - for details see the *CXpro<sup>HD</sup> User Guide (MAN0133)* available from the Cylon support site (<http://support.cylon.com>).

**Note:** It is not required to change the Site Number or Comms Controller preset values. It is however recommended to match the Field Controller address with the MS/TP Station address (see below).

### (If required) Set Device Instance & MS/TP Address

**Note:** This is only possible if the MS/TP address switch is set to Zero.

## Confirm or set MS/TP parameters

**MS/TP Baud Rate** is the Baud rate at which all the other devices on the subnet (Fieldbus) are communicating. All devices **must** be configured for the same baud rate for communications on the subnet.

**Device ID** is the BACnet device instance number. Every BACnet controller within the site must receive a unique BACnet instance number to ensure proper communications. This BACnet instance number should be unique even across subnets. By default, it is set to the entire numeric portion of the Controller's serial number.

**Device Name** is the user-assigned name for the controller. This is not necessary for BACnet communications; however, it is useful to name each controller for organizational purposes.

**APDU Timeout Seconds** leave this at the default setting of 3 seconds.

**MS/TP Station** is the device MS/TP address. This is the unique address users must give each controller on the subnet (Fieldbus).

**MS/TP Max Masters** is the maximum address that this controller will poll when in the “poll for masters” state. Because this is a BACnet master device, it will go into this state to search for the next BACnet master device to pass the token to. To optimize the speed of the network, it is recommended that the last master device on the subnet be set at the maximum MS/TP address on the network. For example, if the last device on the subnet (Fieldbus) is the **CBX** at address 63, then users would set the **MS/TP Max Masters** to 63. This will speed up communications as it will not go into the “poll for masters” state and immediately pass the token back to the **eSC** or **CBM** at MS/TP address 0.

### CONNECT THE CBX-8R8(-H) TO FLX UNITS

The I/O capabilities of a **CBX-8R8(-H)** can be extended by the addition of **FLX-8R8** and **FLX-8R8-H** devices.

These are connected to the **CBX-8R8(-H)** by means of a standard module interconnector (**FLX bus connector**), one of which is shipped with each **FLX** device.

#### Set the FLX address

Each of the FLX units connected to a single CBX must have an address that is unique on that CBX's FLX bus. The address is set by the 5-way DIP switch.

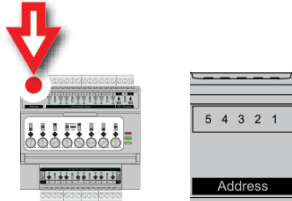

The terminals on a **FLX** unit will be accessible within the CBX Strategy with point numbers prefixed by this address as illustrated below:

| Inter-module bus Address | DIP switch setting | Point numbers |
|--------------------------|--------------------|---------------|
| 00001<br>1               |                    | 101 ... 116   |
| 00010<br>2               |                    | 201 ... 216   |
| 00011<br>3               |                    | 301 ... 316   |

**Note:** If there are 2 devices on the same FLX bus with the same address –including 0, the address of the **CBX** - then the bottom (yellow) status LED will blink slowly to indicate a FLX bus address clash.

#### Join or terminate the FLX bus

Place the devices side-by-side

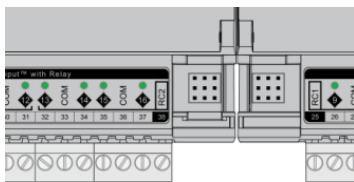

and place the **FLX bus connector** into the two adjacent sockets at once.

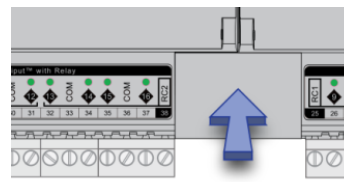

The end device on a **CBX** set (either a **FLX** device or the **CBX** itself if no **FLX** devices are connected) must have a terminator inserted into its interconnector socket. One terminator is shipped with each **CBX-8R8(-H)** device.



#### (If required) Set up FLX bus extension

If a **FLX** device cannot be located beside a **CBX**, **CBXi** or another **FLX** device then The FLX bus can be connected by cable using two **FLX-RMC** Remote Module Connectors, sold separately.

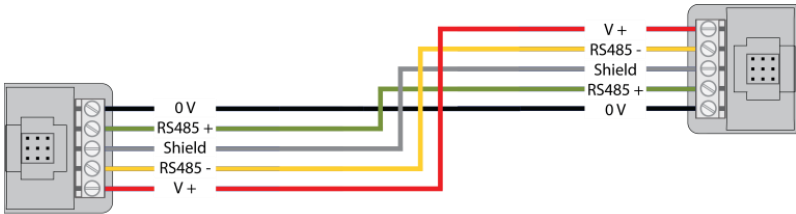

Connect cables to the two supplied **FLX-RMC** screw-terminal connectors as shown above with the appropriate length of cable.

- Note:** Use Copper or Copper Clad Aluminum conductors only. Multiple wired connections can be used between **FLX** modules, but the total **FLX** bus length must be less than 1200 m (3280 ft) for RS-485 communications.
- Note:** The total length of **FLX** bus segments powered by one source (**CBX**, **CBXi** or **FLX-PS24**) must not exceed the following lengths:
- | Cable gauge | Max length     |
|-------------|----------------|
| AWG 18      | 30 m / 100 ft. |
| AWG 22      | 15 m / 50 ft.  |

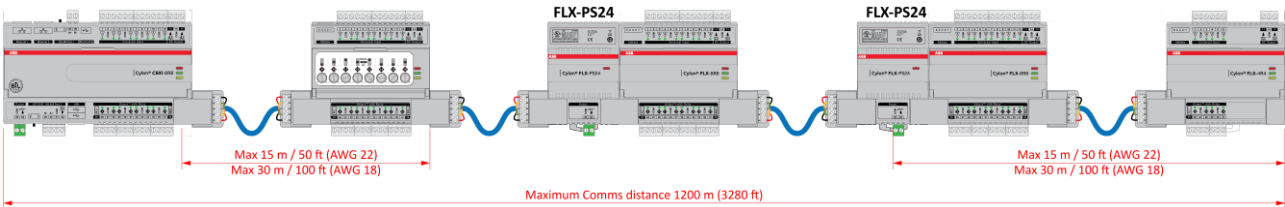

If the RMC is connected to the Left-Hand side of a **FLX-PS24**, then it is not strictly necessary to connect the 0 V and V+ lines:

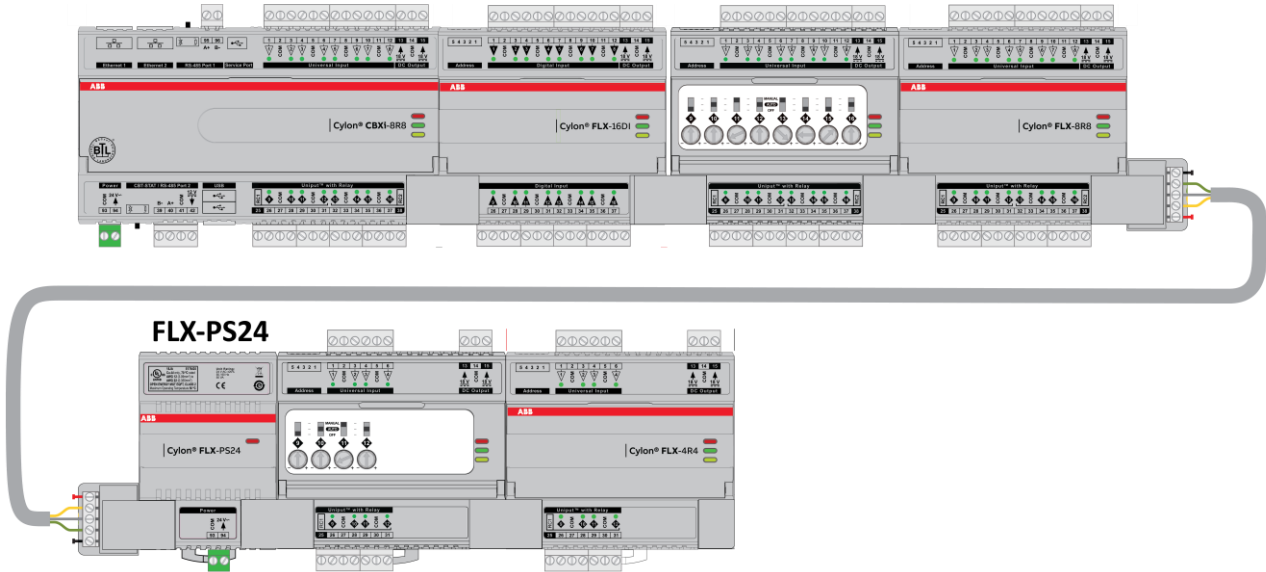



### Attaching RMC terminals

Remove the Interconnect (if installed) from the right-hand side of the **FLX**, **FBXi**, **CBXi** or **CBX** where the **RMC** is to be installed.

Slide one **RMC** connector into the T-slot of the CBX or FLX at the point at which the BUS is to be extended.

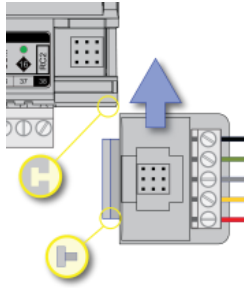

### Replace the Interconnect

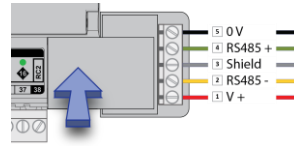
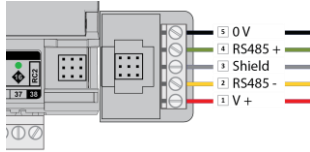

Slide the other RMC connector into the Left-Hand T-slot of the remote **FLX**.

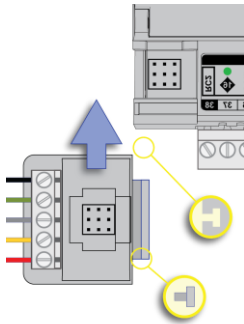

### Insert the second interconnect

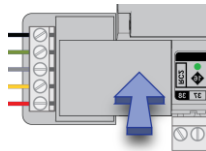
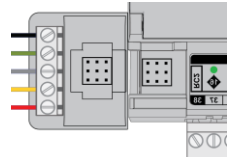

**Note** The termination block can only be used on the right-hand interlink connector of the last **FLX** unit on the FLX bus.

While it is possible, in a multi-tier system, to connect intermediate tiers from right to left to ease installation, the final tier must be wired from left to right so that the FLX bus can be terminated on the RHS connector of the last **FLX** on the bus

## CBX OPERATION

### INPUTS AND OUTPUTS

The **CBX-8R8(-H)**, **FLX-8R8** and **FLX-8R8-H** have identical I/O capabilities – each has a set of 8 Universal Inputs and a set of 8 UniPuts with relay.

**FLX-4R4** and **FLX-4R4-H** have 4 Universal Inputs and 4 UniPuts with relay.

**FLX-16DI** has 16 Digital Inputs only.

Any of the terminals can be configured as inputs. Any of the UniPut terminals can be configured as an output.

#### Input modes

Universal Input terminals and UniPut terminals can be configured as inputs in almost identical fashion:

| Measurement Mode | Universal Input   | UniPut as Input:  | Digital Input |
|------------------|---|---|---------------|
| Resistance       | Resistance measurement<br>Range: 0 ... 450 kΩ<br>Accuracy: ±0.5% of measured resistance   |   | -             |
|                  | Temperature measurement<br>Range: -40 °C ... +110 °C<br>Accuracy: 10k NTC sensors (e.g. 10k Type 2 (10K3A1) or 10k Type 3 (10K4A1): ±0.3 °C, -40 to 90 °C (-40°F to 194°F); ±0.4 °C > 90 °C (194°F) |   | -             |
|                  | Digital Volt-Free contact, 2 mA contact-wetting current   |   |               |
|                  | Pulse counting (volt-free)<br>up to 20 Hz, 25 ms – 25 ms  |   | -             |
|                  | -   | <b>24 V AC Detect</b>   | -             |
| Voltage          | Analog Input<br>Range: 0 ... 10 V<br><b>@ 130 kΩ</b><br>Accuracy: ±0.5% full scale [50mV]   | Analog Input<br>Range: 0 ... 10 V<br><b>@ 40 kΩ</b><br>Accuracy: ±0.5% full scale [50mV]  | -             |
|                  | Pulse counting (0 ... 10 V) up to 20 Hz, 25 ms – 25 ms  |   |               |
| Current          | Current input<br>Range: 0 ... 20 mA<br><b>@ 390 Ω</b><br>Accuracy: ±0.5% full scale [100µA]   | Current input<br>Range: 0 ... 20 mA<br><b>@ 390 Ω</b>   | -             |
|                  |   | <p><b>Note:</b> Current Input requires user-supplied external 390 Ω resistance.</p> <p>Accuracy: depends on user supplied external resistor</p> |               |

**Note:** Inputs use on-board 16-bit analog to digital convertor.

**Note:** All inputs and outputs are protected against short circuit, as well as over-voltage up to 24 V AC.

Hardware point numbers for these inputs in the **CBX-8R8(-H)**'s strategy:

|         | CBXi     | FLX address 1 | FLX address 2 | FLX address 3 |
|---------|----------|---------------|---------------|---------------|
| Inputs  | 1 ... 8  | 101 ... 108   | 201 ... 208   | 301 ... 308   |
| Outputs | 9 ... 16 | 109 ... 116   | 209 ... 216   | 309 ... 316   |

**Resistance Input mode (Passive Input)**

Passive Inputs are all those devices that vary in resistance, including switch contacts.

|                 | Resistance measurement | Temperature Measurement | Switch Contact | Pulse counting | 24 V AC Detection |
|-----------------|------------------------|-------------------------|----------------|----------------|-------------------|
| Universal Input |                        |                         |                |                | n/a               |
| Uninput         |                        |                         |                |                |                   |

These all require a current supplied by the **CBX-8R8(-H)** terminal so that this resistance can be measured.

The passive sensor types supported by the **CBX-8R8(-H)** are:

- Pre-programmed Passive Temperature Sensors.
- Potentiometer (normally used as a 0 to 10 KΩ or a 1 KΩ to 11 KΩ variable resistor to give a 0 to 100 % output).
- Volt-Free Digital Input (the controller strategy measures the contact resistance and gives a 0 or 1 output).
- Straightforward Resistance measurement. This can be used with the **Make Linear** block to give a temperature output for temperature sensors that are not factory pre-programmed into the **CBX-8R8(-H)**.

In **CXpro<sup>HD</sup>** simply select 'Resistance' sensor type in the **Point Module** and select **Pulsed** in the **Advanced** parameters (the Pulsed option increases accuracy by eliminating any self-heating in the passive temperature sensor, while the Continuous option can trade absolute accuracy for speed).

In Passive Input Mode the Uninputs and Universal Inputs configure like this:

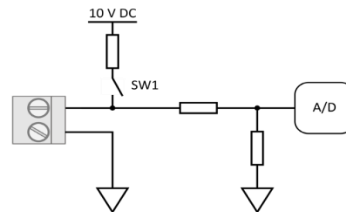

**Note:** The reference voltage can be pulsed or continuous, using the solid state switch. A pulsed reference gives optimum accuracy by eliminating self-heating in the sensor, and this is the default setting.

UniPut 24 V AC Detection

If 24 V AC is connected to a Uniput terminal, then the 24 V AC Detect circuit will detect this and will open switch SW1. SW1 stays open for the duration of the 24 V AC state. When 24 V AC is removed from the Uniput terminal then the short circuit or open circuit states can again be detected.

**Voltage input mode (Active Input)**

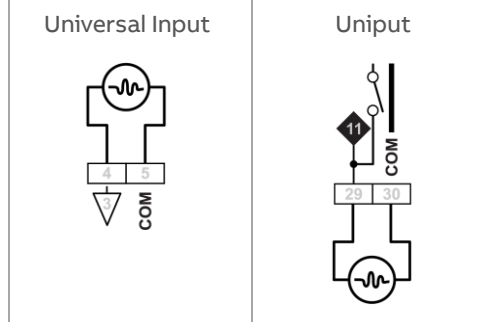

**Note:** Input Impedance for Universal Input terminals is 130 kΩ.  
Input Impedance for Uniput terminals is 40 kΩ.

The 0 ... 10 V input is used for Active analog and binary measurements. 'Active' means that there is no current supplied by the **CBX-8R8(-H)** for the sensor, as the signal is generated completely by the Sensor.

The 'mV' sensor setting gives a value between 0 and 10,000, which represents voltage in mV.

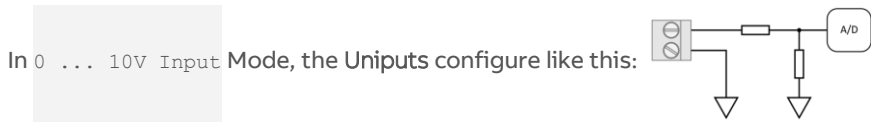

**Current Input mode (Active Input)**

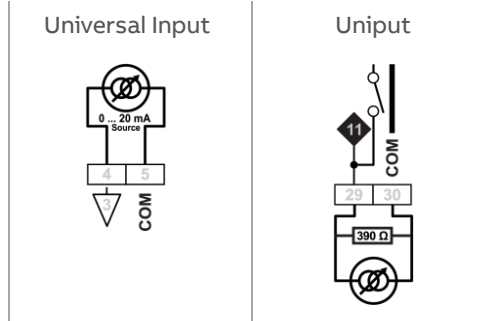

The Current Input is used for 0 ... 20 mA or 4 ... 20 mA Active sensors.

4 ... 20 mA scaling can easily be achieved using **CXpro<sup>HD</sup>** by entering range values in the Point Module 'Advanced' parameters.

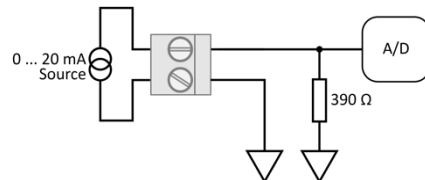

### Output modes

UniPut terminals can generate an output as follows:

- Analog Output 0 ... 10 V, 20 mA, 12-bit resolution
- Digital Output 0 ... 10 V, 20 mA
- Relay Contacts with ability to switch up to 24 V AC  
Maximum Load: 24 V AC, 2 (1) A resistive (inductive) for all relay contacts

#### Analog 0 ... 10 V output mode

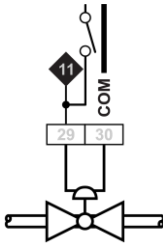

In Analog 0 ... 10 V output Mode, the Uniputs configure themselves like this:

where the D/A is the digital to analog converter. All circuitry is fully protected against 24 V AC.

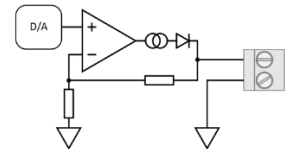

#### Digital 0 ... 10 V output mode

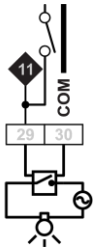

In Digital 0 ... 10 V output Mode, the Uniputs configure in the same way as for analog:

In this mode the output toggles between the voltages defined as “ON” and “OFF”.

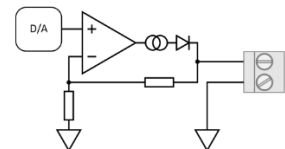

#### Relay Mode

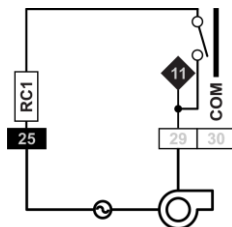

In Relay mode the Uniputs are configured with a single relay common for each half of the terminals:

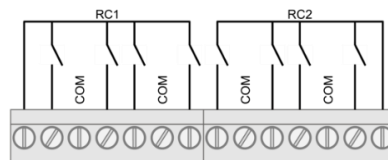

## AUXILIARY POWER OUTPUTS

The **CBX** and **FLX** modules each have two 18 V DC outputs, for I/O devices that require loop power.

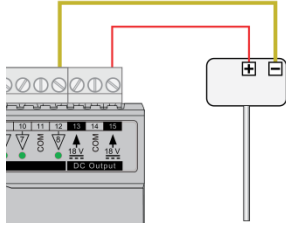

For 3-wire connections return can be through any COM terminal, but it is recommended that Auxiliary power wiring is through terminal 14, the COM between the two Auxiliary power terminals.

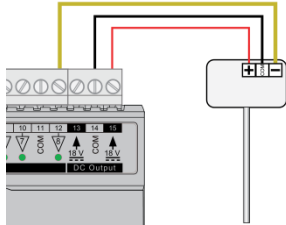

The DC output terminals provide a minimum of 18 V DC, but the combined load (on each IO module) must remain below 60 mA.

## USING A KEYPAD WITH THE CBX

A **CBT-STAT** or **UCU Room Display** keypad can be connected to the **CBX** at the CBT-STAT port.



**Note:** If UCU Room Display is used, refer to the *DS0064 UCU10FC/K* for the corresponding Strategy Point Setup.

## OUTPUT OVERRIDE

HOA variants (**CBX-8R8-H**, **FLX-4R4-H** and **FLX-8R8-H**) include hardware override switches for each of their outputs. The override controls are located behind the flap on the front of the device:

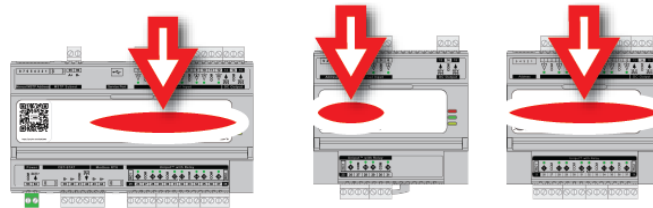

**CBX-8R8-H / CBXi-8R8-H**

**FLX-4R4-H**

**FLX-8R8-H**

These controls consist of a switch and a rotary knob for each output:

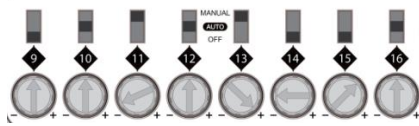

The channel number corresponding to the switch is shown directly below the switch.

The switch can be set to one of 3 positions:

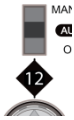

When a switch is set to the **Centre position** the corresponding output channel is set to **Auto** mode – the output is controlled by strategy.

The rotary knob has no effect in this mode.



When a switch is set to the **Bottom position** the corresponding output is forced to **Off** – both the strategy setting and the rotary knob have no effect.



When a switch is set to the **Top position** the corresponding output is set to **Manual** mode

- for digital outputs, the output is forced **on**
- for analog outputs the rotary knob setting controls the output value.

**Note:** Manual position is supervised, i.e. the strategy is aware of the manual value.

The Controller Strategy can determine if an override is in place is by connecting to the **Override** point on the output module:

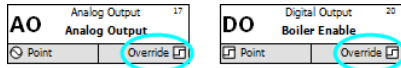

The value of the **Override** point will be '0' when the output is active and '1' when the point has been manually overridden. This allows the strategy to react to the fact that a point has been overridden.

**Note:** The corresponding terminal LED will indicate the override condition.

## 5 Configuring the Cylon BACnet System

### HOW TO INSTALL CYLON ENGINEERING CENTER SOFTWARE

In order to configure **Cylon BACnet** Field controllers, you must install **Engineering Center (EC)** v6.75 or later. To do this, run the program `Cylon Engineering Center Setup.exe` on the **Cylon Engineering Center** installation CD

Press next on the installation screen,

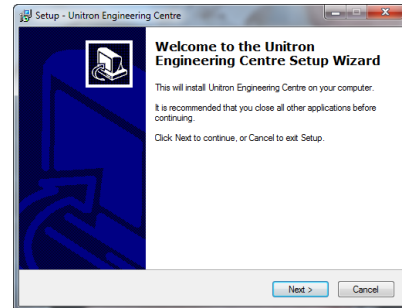

then read and accept the License Agreement

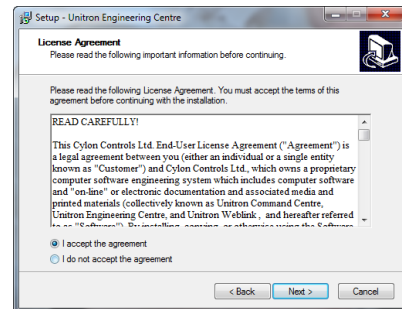

Specify the location into which the **Engineering Center** will be installed.

**Note:** Make sure there are no spaces in the location, and that none of the following characters are used: . ! \$

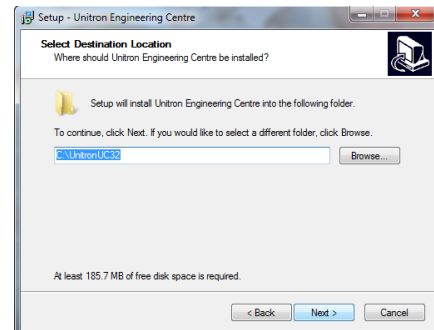

Enter a name for the **Engineering Center's** Windows Program Group.

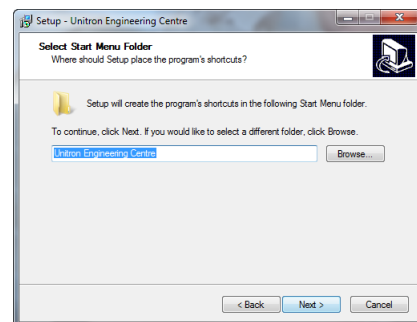



# ABB Cylon® BACnet | Configuring the Cylon BACnet System

If you would like a Desktop Icon for the **Engineering Center**, check the box on the **Select Additional Tasks** dialog.

You can also specify if you want to use US imperial units for sensor readings, or not.

Click **Next**.

Click the **Install** button to start the install process...

You will be prompted to configure the BACnet Connection Settings.

The **PC Device Instance Number** will be set to “-1”. This must be changed to a unique Device Instance Number.

In the **Network Adapter** drop-down list, select one of the PC’s network adapters to be used as the channel for all BACnet communication.

If you wish to connect to a remote BACnet Site, enter that Site’s IP address in the **BBMD settings** section.

If the **Engineering Center** will connect to the BMS Site through a Serial Connection, that connection can be configured in this dialog.

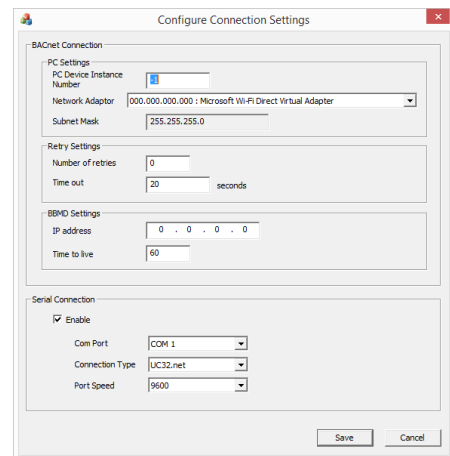
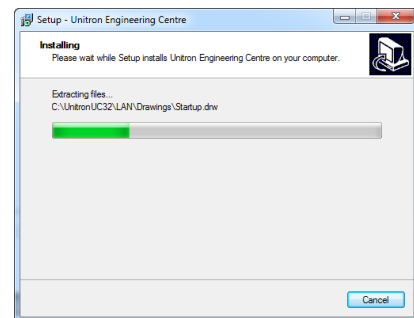
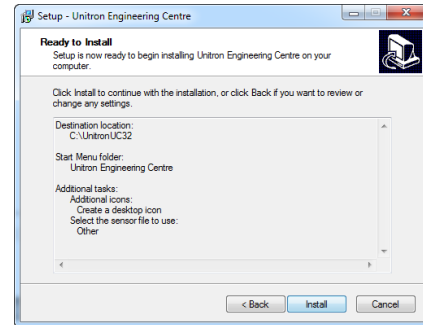
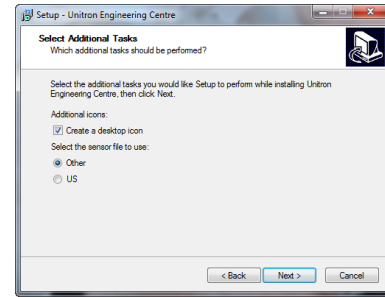

**Note:** Unlike the other settings in the **Configure Connection Settings** dialog, the **Serial Connection** setting applies to both BACnet and Untron Sites.

# ABB Cylon® BACnet | Configuring the Cylon BACnet System

When the **Configure Connection Settings** dialog is complete, click **Save**.

You will be offered the option to install the security dongle driver. If you have already installed a Cylon dongle on this PC you can skip this step.

If you select **Yes**, the HASP driver will be installed.

If the dongle you are installing is a Software Dongle, you will need to generate a fingerprint file. You can do this now, or at a later time.

If you choose to collect the fingerprint information now, the fingerprint file will be generated, but you must remember to **email it to Cylon** in order to receive the Software Dongle.

**Cylon Engineering Center** is now installed. If prompted, you may need to restart the PC before using the **Cylon Engineering Center**.

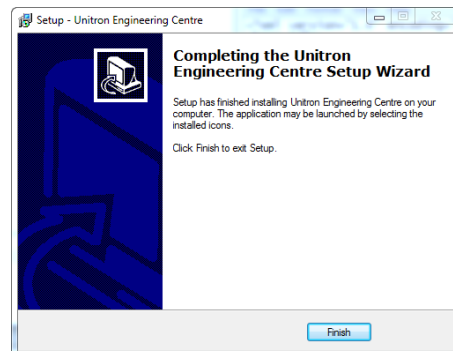
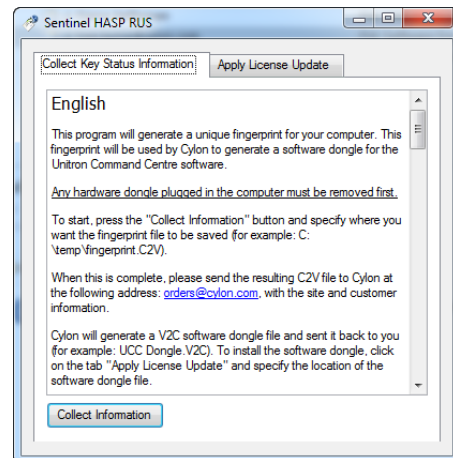
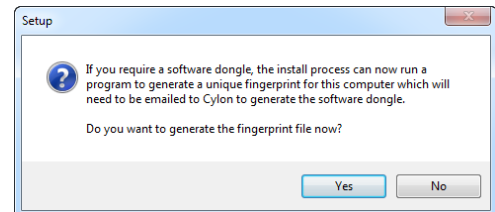
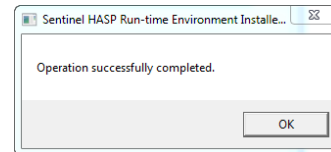
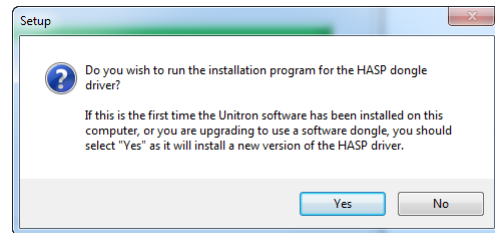

## HOW TO CONFIGURE CYLON BACNET FIELD CONTROLLERS

### STEP 1: CHOOSE A NETWORK ADAPTER FOR BACNET COMMS

When the **Engineering Center** is first started (after initial installation) the BACnet properties must be set. These properties are the identity of the Network Adapter that will be used to connect the PC to the BACnet System, and the Device Instance Number of that Network Adapter in the BACnet system.

To do this, open the **Cylon Configuration utility** from the **Engineering Center**, click on the **Settings** menu and select **Port Handler Settings > BACnet Settings**.

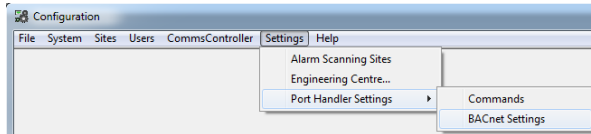

The **BACnet Properties** dialog will appear. The **Device Instance Number** will be set to “-1”. This must be changed to a unique Device Instance Number.

In the **IP Address** drop-down list, select one of the PC’s network adapters to be used as the channel for all BACnet communication. Set the **Subnet mask** in accordance with the local network policy – if in doubt ask your local Network Administrator. The default is “255.255.255.0”.

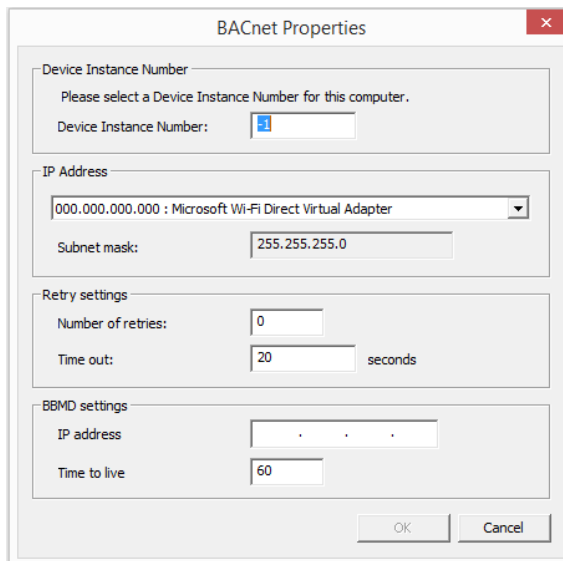

It is recommended that the **Number of Retries** is left at 0 unless there is a clear reason for changing it.

**Note:** In order to avoid conflicts with PortHandler settings for get and set, the BACnet timeout should be set to Number of retries = 0 and Time out = 20 seconds.

If you wish to connect to a remote BACnet Site, enter that Site’s IP address in the **BBMD settings** section.

Click **OK** to save these settings.

## STEP 2: SET UP THE SITE IN THE ENGINEERING CENTER

### Create a Site

Whether a Field Controller is to be on a BACnet Site or a Unitron Site, the Site must be created in the **Cylon Engineering Center**, and controllers set up on it in the usual way (see *MAN0100 Configuring the Cylon Software System* for details).

However, if the Site is to be a BACnet Site, then this must be specified in the **Site Configuration** dialog **Site Details** section (click on the **BACnet** radio button):

Site Configuration

Site Details:

Site Description: HQ Block 2

Directory name: HQBLOCK2

Site Number: 3

Serial Connection

- Unitron
- BACnet

Remote Connection

- Unitron Modem
- Unitron TCP/IP
- BACnet IP

Reset

Controller Type Connection

Type: BACNET IP

**Note:** The BACnet options will only be available if you are running the **Engineering Center** with a **CEC BACnet Licence**. (The hardware dongle should have “CEC BACnet” printed on it)

If the Field Controller will be connected to the **Engineering Center** by direct RS232 link (which is required for the initial setup of the device), set the **Controller Type Connection** to **UC32** or **UCU**.

If the Field Controller will be connected to the **Engineering Center** via a BACnet router, set the **Controller Type Connection** to **BACnet**.

**Note:** Once a BACnet Site has been added (once the Add button is pressed) it can never be changed to a non-BACnet Site in software, because the controllers must be physically changed in order to change the nature of the Site.

This also means that you cannot copy or convert an existing **Unitron** Site to create a BACnet Site.

### Add controllers to the site

Open the **Edit Controller Descriptions** dialog in the usual way, by clicking the **Edit Controllers...** button in the **Site Configuration** dialog.

Edit Controller Descriptions - HQ Block 2

Comms Controllers on Site:

HQ Block 2

| Address | Name /                    | Type     | Device ID | Dupli | Total |
|---------|---------------------------|----------|-----------|-------|-------|
| 1       | 001 - Network             | CBR      |           |       | 6     |
| 2       | 002 - Floor 1 East        | CBR2     | 356       |       |       |
| 3       | 003 - Floor 1 West        | CBR2     | 356       |       |       |
| 4       | 004 - Ground Floor E      | CBR2/MOD | 86395     |       |       |
| 5       | 005 - Ground Floor W      | CBR2/MOD | 86395     |       |       |
| 6       | 006 - Ground Floor Meters | CBR2/MOD | 86395     |       |       |

Field Controller on Subnet

001 - Network

| Ad. | Name        | Type  | BACnet D. | Total |
|-----|-------------|-------|-----------|-------|
| 1   | 001 - CBM24 | CBM24 | 1         | 1     |

Add... Edit... Delete... Generate Names... OK Cancel

The controller types available for use in BACnet Sites include: BACnet Comms Controllers (**CBR**), and BACnet Field Controllers (**CBM**, **CBX** and **CBT**).

## Adding a CBR

Before adding Field Controllers, one or more fieldbuses (Subnets) must be defined. These are defined by **CBRs**, but a **CBR** can cover one, two or three fieldbuses depending on the **CBR** type. The fieldbuses can be MS/TP or Modbus.

To add a **CBR**, click on the **Add...** button under the **Comms Controllers on Site** list.

Select the **CBR** type from the **Default Type** menu:

For a basic **CBR** just one fieldbus is available, as shown above. The number of fieldbuses available on a **CBR** depends on the type of **CBR**. MOD variants include a Modbus fieldbus. The dialog for a **CBR/MODex** shown below displays a tab for every possible fieldbus:

You must assign a fieldbus address and name to each fieldbus, and assign a BACnet Device Instance Number to the **CBR**.

**Example:**

In the example below, a **CBR/MODex** has been set with:

- an MS/TP bus 'Ground Floor E' (fieldbus address 4), and
- a Modbus bus 'Ground Floor Meters' (fieldbus address 6):

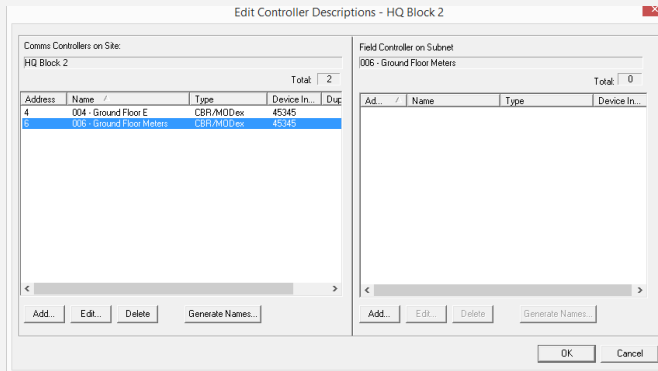

**Note:** You can add multiple **CBRs** at once by clicking the **Generate Names...** button and specifying a Name format and a starting Device Instance Number.

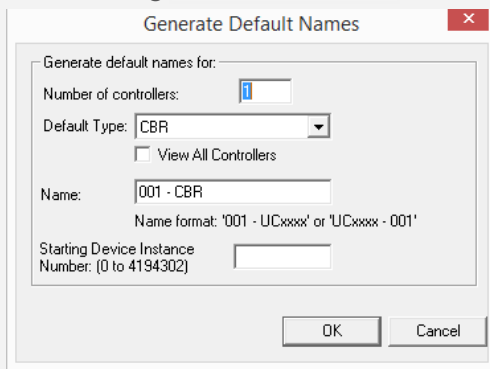

## Adding a Field Controller

Every Field Controller added to a **CBR** must be one of the BACnet Field Controllers listed at the start of this document.

To add a Field Controller, select the fieldbus (Subnet) to which the Controller will be attached and click on the **Add...** button under the **Field Controllers on Subnet** list.

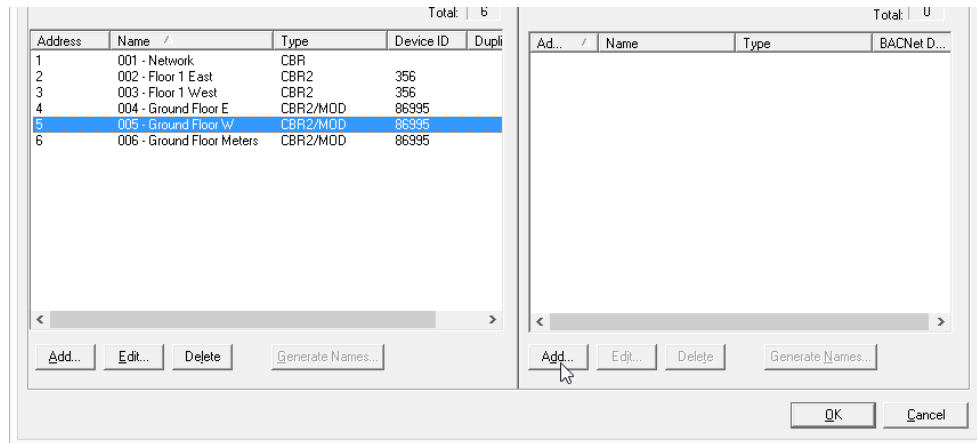

This opens the **Edit Field Controller Details** dialog:

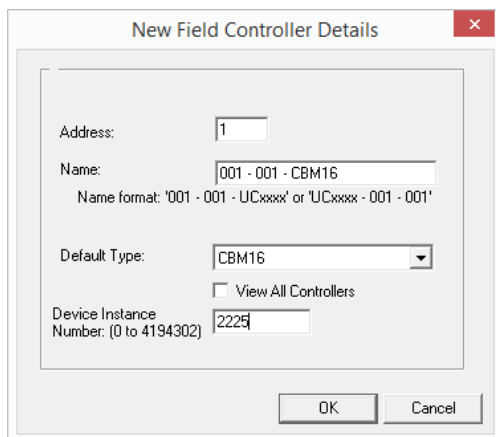

The next available controller address is automatically assigned, but you can manually enter a different value in the **Address** field.

Enter a name for the Field Controller in the **Name** field.

Select the Field Controller type from the **Type** drop down list. By default, only controller types from the current product range are listed. However, if the 'View All Controllers' box is ticked, all supported controllers will be listed. Click the **OK** button to confirm the choices that you made in the dialog.

**Note:** A controller name cannot be more than forty characters long.

For BACnet sites only, the **BACnet Device Instance Number** must be set. This must be an ID for this controller that is unique within the Cylon BACnet Site.

**Note:** The number set here in the **Cylon Engineering Center** must match the **Device Instance Number** set in the Field Controller.

## Editing Controller information

Clicking the relevant **Edit** button while a Comms Controller or Field Controller is selected causes an **Edit** dialog to open, which has identical parameters to the corresponding 'New' dialogs above. If you change the values of any of the parameters in an Edit dialog, and click the **OK** button then the parameters of the selected Controller will be updated to match the dialog.

## FLX I/O modules

If the site includes **CBX-8R8** devices, their I/O capabilities can be expanded by adding **FLX-8R8** devices. The expanded I/O must be configured on each **CBX-8R8** device as follows:

In the New Field Controller Details dialog change the Controller Type to **CBX8R8** :

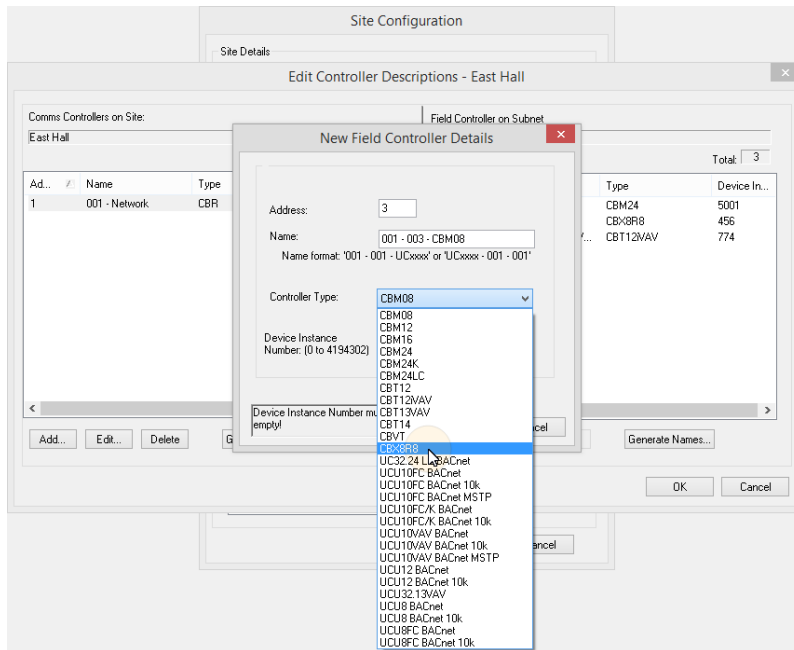

An **I/O Modules** table will become visible in the **Field Controller** Details dialog:

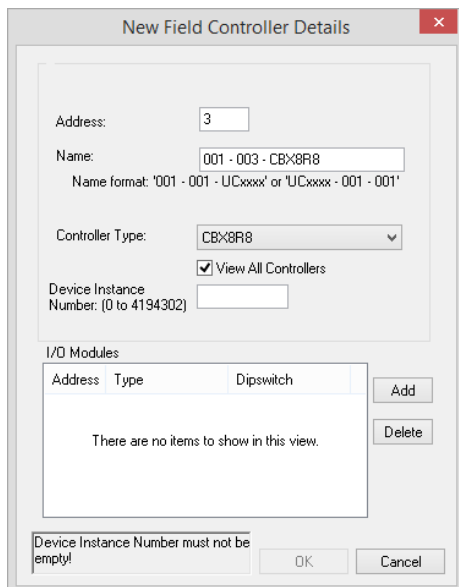



# ABB Cylon® BACnet | Configuring the Cylon BACnet System

If the **CBX** device has one or more **FLX** modules connected to it, add the same number of entries in the **I/O Modules** table:

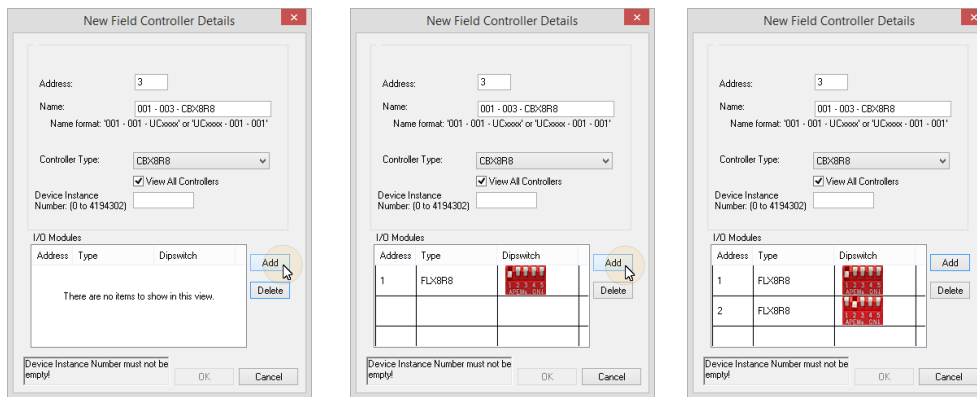

If you attempt to add more modules than the **CBX** can support, an error message will be displayed:

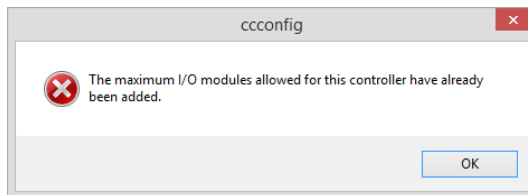

When the correct number of **FLX** modules have been configured, enter a **Device Instance number** and click **OK**.

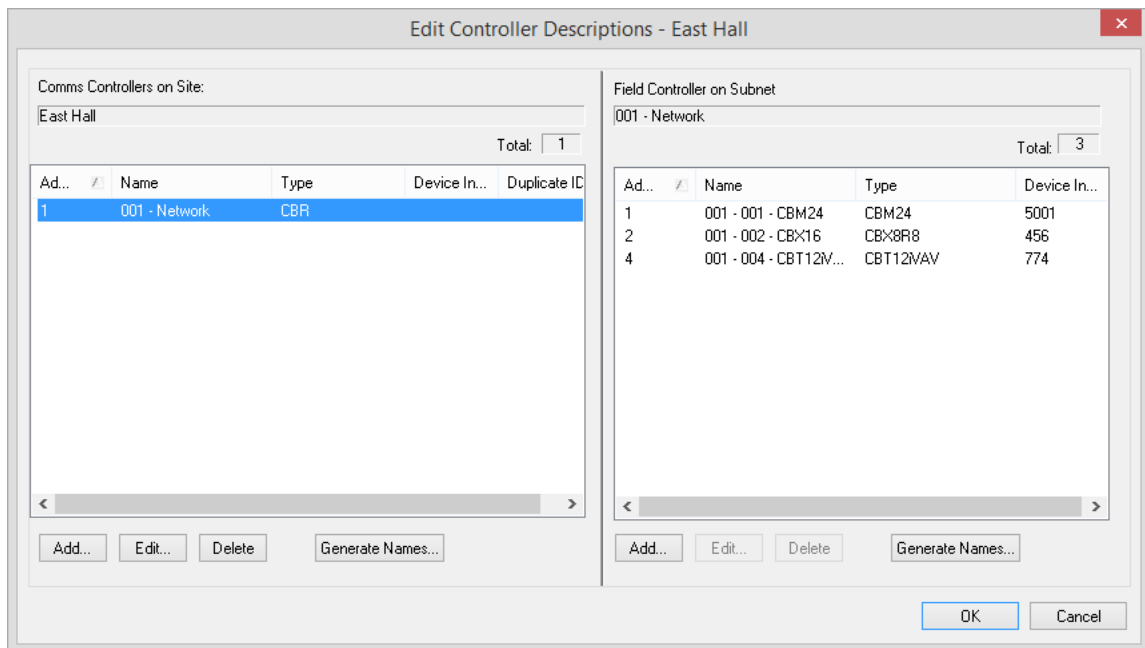

**Note:** The IO module configuration can be changed later by opening the **FLX Module Configuration** dialog from the **Site Tree**:

# ABB Cylon® BACnet | Configuring the Cylon BACnet System

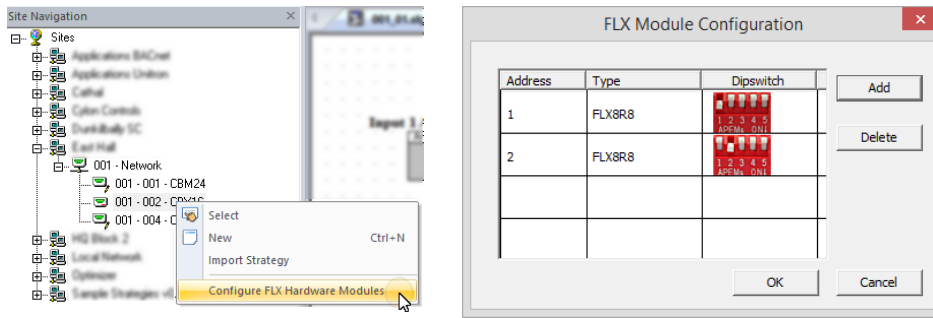

In the Strategy drawing, IO blocks can be added up to the total on the configured **FLX** modules plus the **CBX** onboard IO.

**Note:** If a **FLX** module is deleted from a **CBX** configuration (in **CCConfig**) after the Strategy drawing has been set up, the blocks associated with that **FLX**'s IO will be 'greyed out' to indicate that they are inactive.

**Note:** You can add multiple **CBRs** at once by clicking the Generate Names... button and specifying a Default Type, a Name format and a starting Device Instance Number.

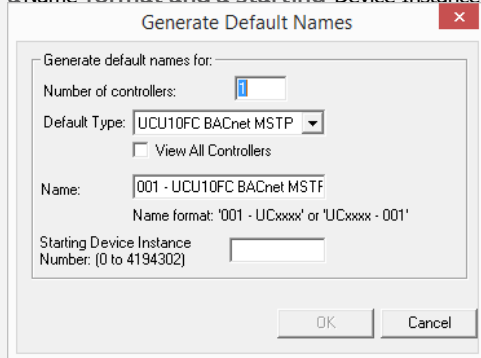

### STEP 3: CONFIGURE THE CONTROLLER'S BACNET SETTINGS

When a Field Controller is first commissioned, its address must be set by connecting **Engineering Center** directly to the controller by RS232 link (Service Port). If points on the controller are to be exposed on a BACnet network, or if the **Engineering Center** is to communicate with the Field Controller over BACnet, then the Field Controller's BACnet address (Device Instance Number) must also be configured.

The device's BACnet settings can be read and modified via a number of different tools, each described in

# ABB Cylon® BACnet | Configuring the Cylon BACnet System

*Appendix:* Quickstart Guide on page 106.

To accomplish this commissioning task using the **Engineering Center**, proceed as follows:

**Note:** Some parameters can be set over Ethernet connection, but Controller Address and Baud Rate can only be set when the Engineering PC is connected to the controller by RS232 link.

**Note:** Service Port (serial connection) must not be connected until after the device is powered on.

In the **Cylon Engineering Center**, select **Configure BACnet Device** from the **Communications** menu

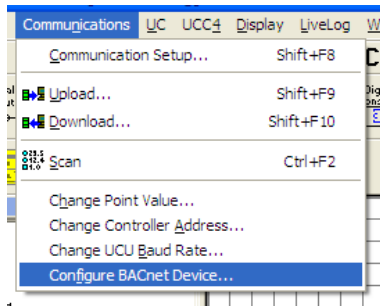

This opens the **Device Properties** dialog, which defines how the Controller will communicate on the BACnet network, and how it will communicate with **Cylon Engineering Center** for configuration over BACnet.

In this dialog, each current value and the proposed new values can both be displayed at once. Defaults can also be automatically generated.

## Device Properties

| Device Properties      | Controller Values | Config Values    | New Values       |
|------------------------|-------------------|------------------|------------------|
| Controller Address     | 11                | 11               |                  |
| Device Instance Number | 18101             | 18101            |                  |
| Device Name            | 011 - FCU_8_34_S  | 011 - FCU_8_34_S | 011 - FCU_8_34_S |
| Site Number            | 8                 | 8                | 8                |
| Comms Ctrl Number      | 181               | 181              | 181              |
| MSTP Max Masters       | 127               |                  | 127              |
| APDU Timeout (Seconds) | 10                |                  |                  |
| MSTP Baud Rate         | 38400             |                  |                  |

Advanced...      Receive      Send      Use Config Values

Successfully received information from controller.

Close

**Note:** Only Device Name, Site Number, Comms Ctrl Number and MSTP Max Masters will be editable from the **Engineering Center** when the Engineering PC is connected over Ethernet. In order for the **Engineering Center** to edit the other parameters, it must be connected to the Controller by RS232 serial link (Service Port). See

*Appendix: Quickstart Guide on page 106 for other options.*

The parameters that define how the Controller communicates on the BACnet system are:

## Device Instance Number

Enter the required BACnet address (0 – 4194303).

**Note:** The number set here in the Field Controller (when connected serially) must match the Device Instance Number set in the **Cylon Engineering Center**.

## Device Name

Any descriptive text.

## Tunneling Properties: Site Number, Comms Ctrl Number and Controller Address

**Note:** All of the Cylon controllers throughout the BACnet system must have the same **Unitron** “Site Number”. Broadcast globals will not work if this is not the case.

In the Device Properties dialog set the Site Number and Comms Ctrl Number matching the position of this Controller in the Site defined in the **Cylon Configuration utility (CCConfig)**.

|                   |     |   |     |
|-------------------|-----|---|-----|
| Site Number       | 5   | 5 | 5   |
| Comms Ctrl Number | 1   | 1 | 1   |
| MSTP Max Masters  | 127 |   | 127 |
| APDU Timeout      | 10  |   |     |

## MSTP Max Masters

This must be equal to or greater than the highest address used on the BACnet MS/TP fieldbus, because this controller will not pass data to devices with addresses higher than this. All of the controllers on the MS/TP trunk have their **Max Masters** value set to 127 with the exception of the highest numbered Controller. In an optimized network the highest numbered controller will have a **Max Masters** setting set to its own address or to one number higher than its address.

**Note:** It is recommended that you address your controllers consecutively starting at 1. For optimum efficiency there should be no gaps in the device addresses.

## APDU Timeout

(0 - 60 seconds) this value should be left at its default unless there is a problem.

## MSTP Address (not visible by default)

This is the BACnet address of the Field Controller on the Cylon BACnet fieldbus (0 - 127).

It is recommended that this is set to the same value as the Controller Address, which is the Unitron address of the Field Controller on the fieldbus (1-255). By default these are set to the same value, 1-127, and the MSTP Address field is no available to be edited. However, it is possible to set a different BACnet address if required. To do this, click the **Advanced...** button, to open the **BACnet Device Setting Advanced Options** dialog:

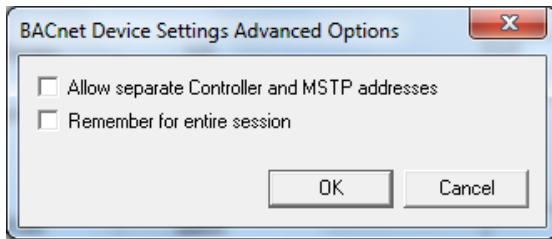

Tick the **Allow separate Controller and MSTP addresses** checkbox

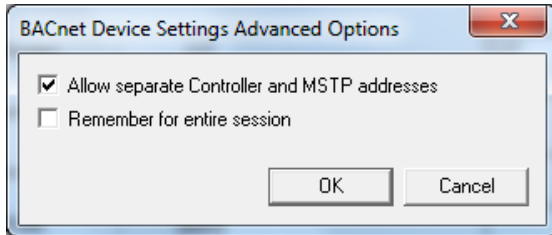

And click **OK**.

The **Device Properties** dialog will now show the **MSTP Address** parameter, allow it to be edited if the Controller is connected by RS232 Serial Connection:

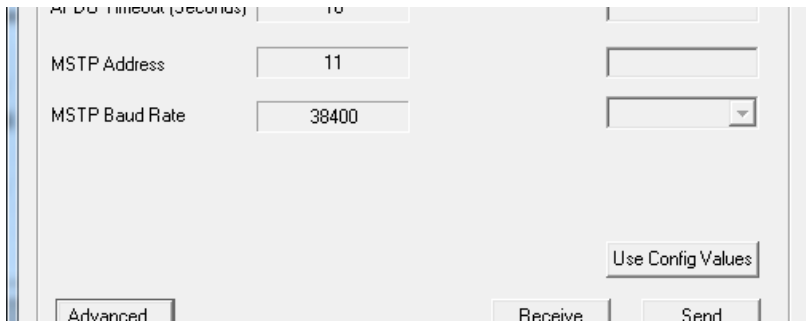

If this value is changed, then a warning will be displayed that the Cylon Engineering Center must be restarted before the Engineering Center will be able to communicate with the controller over IP (it is currently connected serially to make the change)

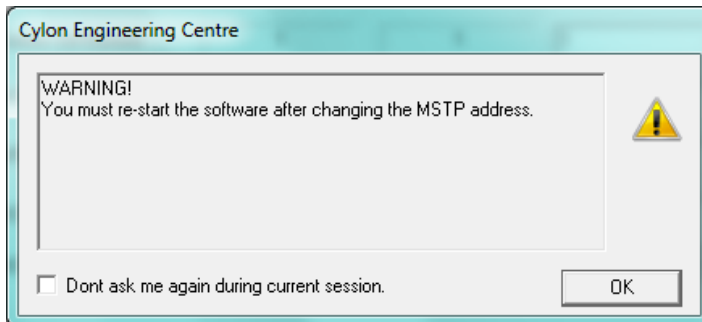

## STEP 4: SPECIFY THE POINTS THAT ARE TO BE EXPOSED ON THE BACNET SYSTEM

When the Strategy for the BACnet controllers has been configured, the points within the controller that are to be available to the BACnet system must be specified by selecting **Configure BACnet Points...** from the **UC32** or **UC** menu in the **Cylon Engineering Center**

The **Configure BACnet Points** dialog opens, listing all of the points used in the Strategy:

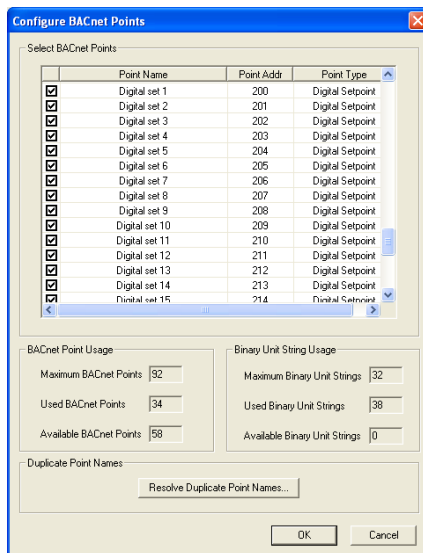

Ensure that the checkbox beside each of the points that are to be exposed is ticked, and then click on **OK**.

**Note:** By default all of the checkboxes are ticked.

**Note:** In BACnet, the point name must be unique. In the **Cylon BACnet** system they may not be unique, so some duplicate names may appear in the list. If this is the case, click the **Resolve Duplicate Point Names...** button. This opens the **Resolve Duplicate Point Names** dialog, where names can be changed.

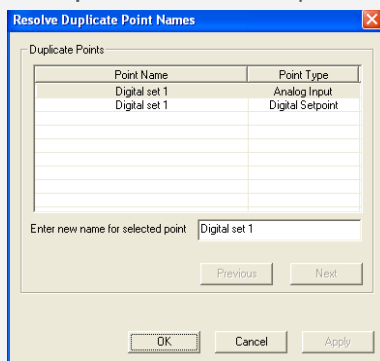



### STEP 5: DOWNLOAD THE CONFIGURATION TO THE CONTROLLER

When the Strategy has been fully configured, download it to the Controller in the usual way (see *MAN0100 Configuring the Cylon Software System* for details), ensuring that **BACnet Points Config** is ticked.

**Note:** When you download a Strategy to a BACnet controller from the **Engineering Center** or **Site Organizer**, any configuration that has been set by a separate B-OWS – e.g. an Alarm Recipients list – will be wiped. You must re-download the Alarm Recipients list, and any other B-OWS specific configuration after the Strategy download is complete.



**Note:** The BACnet Points Config option will only be available if you are running a BACnet-enabled installation of the **Engineering Center**.

If you want to manually download a subset of BACnet points, click on the **BACnet Points** button. This opens the **Select BACnet Points for Download** dialog where you can select or deselect points for download:

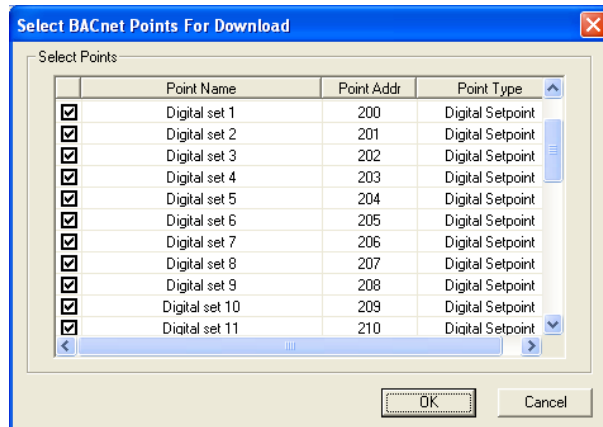

The System is now configured, and the required Points available to the BACnet system.



## BACNET EXPLORERS

The **Cylon Engineering Center** includes two utilities that facilitate the commissioning of BACnet Sites: the integrated **Discovery Tool**, accessible from the **Site Tree**, and the separate application **NB-Pro**.

### NB-PRO

**NB-Pro** is a generic BACnet scanning tool suitable for reading and writing to and manufacturer's BACnet devices including native Cylon devices. **NB-Pro** is particularly useful in reading and writing complex BACnet data that is not currently accessible via the block diagram including alarming data, scheduling data, proprietary properties, etc.

**NB-Pro** has an integrated Manual/HelpFile that is accessible from within **NB-Pro** either from the Help tab or by pressing the F1 key.

### DISCOVERY TOOL

The purpose of the **Discovery Tool** is to allow users to see all live BACnet devices on the network from the **Cylon Engineering Centre**. It aids in the rapid configuration of a live site by allowing some or all of the discovered controllers to be automatically added to a site in the **Engineering Center**.

#### BACnet Explorer

The Explorer is an extension of the Discovery Tool. It is available in the **Engineering Centre** by right-clicking on a BACnet Site in the **Site Tree** and selecting **Discover Site**.

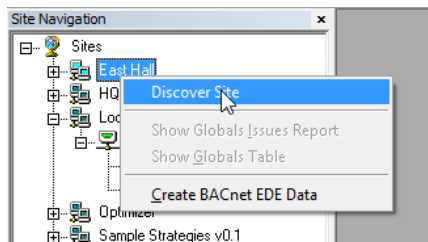

This opens the **Site Discovery** dialog, which is prefilled with the selected Site's information:

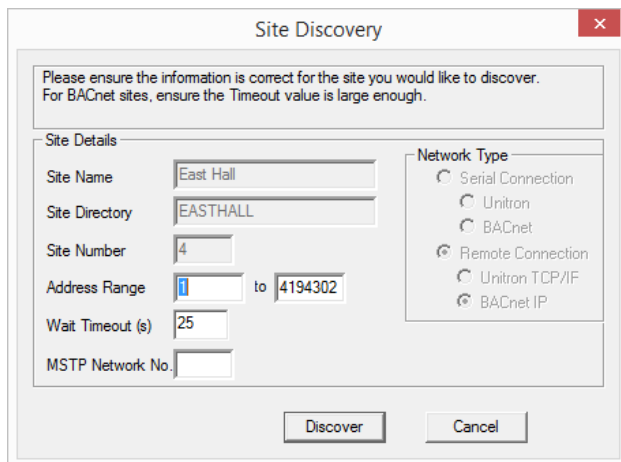

If the **Discover Site** option is selected from the context menu of the Site Tree's root node,



then the **Site Discovery** dialog will be blank, and can be used to create a new Site.

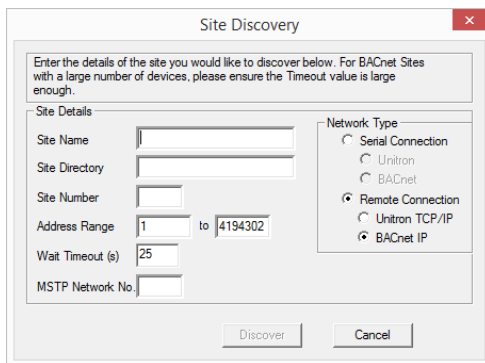

The **Site Discovery** dialog has the following fields:

### Network Type

(If an existing Site is selected, this selection cannot be changed).

If a Site is not selected, select a Network Type that will apply if you choose to create a Site from the Explorer during the current exploration:

- Serial Connection for directly-connected Sites
- Remote Connection for Sites connected over TCP/IP

### Site Name

(If an existing Site is selected, this field will not be editable).

If a Site is not selected, enter a new Site Name here. If you choose to create a Site from the Explorer during the current exploration, this is the name that will be used for it.

### Site Directory

The **Site Directory** is automatically generated from the **Site Name**, but it can also be user defined. Do not use special characters in the **Site Directory** Name.

### Site Number

(If an existing Site is selected, this field will not be editable).

If a Site is not selected, specify a **Site Number**. If you choose to create a Site from the Explorer during the current exploration, this is the Site Number that will be used for it.

### Address Range

This can be used to limit the Discovery process. Only BACnet devices with Device Instance Numbers within this range will be tested.

### Wait Timeout (s)

This sets the length of time that the process will listen for I-Am responses during discovery.

Larger Sites require higher **Wait Timeout(s)** to explore the entire Site (default 25 seconds)

## Network

The user can choose a specific MS/TP network to discover in this dialog box. If the user enters a network number, only devices on that network will be displayed. Leave this blank if you want to show devices on all networks.

The **Discover** button will launch the progress dialog.

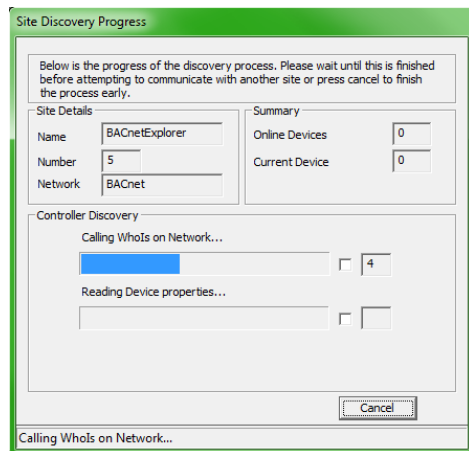

A **WhoIs** call is made, and then the system waits for the specified timeout (default is 25 seconds) after which it reads the BACnet information for each Device that responded with an **I-Am** message. When this is complete, the results dialog opens:

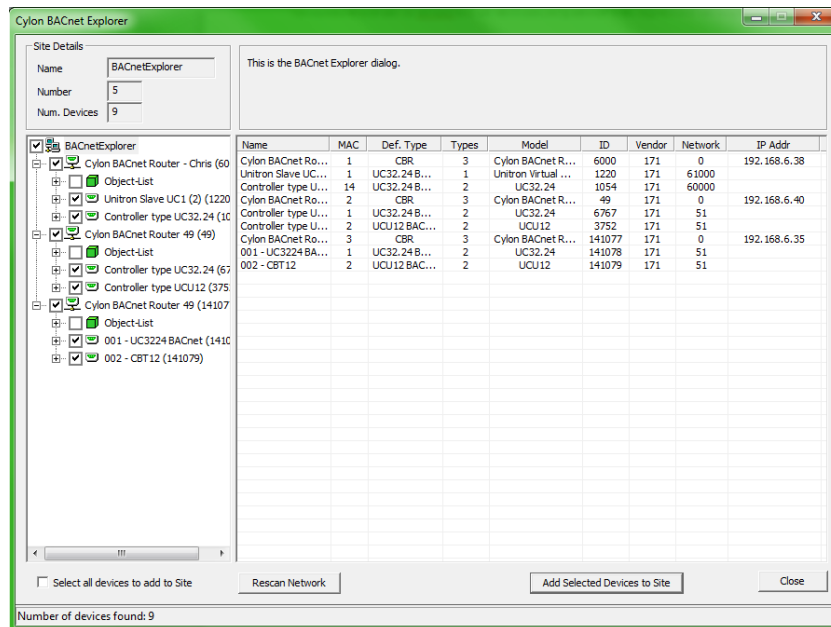

The results dialog contains two panels:

- The left panel contains a tree view list of the BACnet devices and objects discovered.
- The right contains information regarding the selected device or object.

## Rescan

It is possible that not all devices would be discovered during the specified **Wait Timeout(s)**, so if necessary you can re-scan the network for further devices by clicking the **Rescan Network** button. The **Site Details** dialog will open again so that the settings for **Address Range**, **Wait Timeout(s)** and **Network** number can be

# ABB Cylon® BACnet | Configuring the Cylon BACnet System

adjusted. Devices that have already been discovered will be skipped, so that further devices may be discovered even if none of the settings are changed.

## Tree View

The tree view is similar to the existing Site list in other applications. The Site is the root node of the tree, followed by the routers and then devices under those. Under the device nodes there are other nodes in the Object List. Expanding this will show each object read in from the parent device.

## Add selected Devices to Site

As an extension of the **Site Discovery Tool**, the Explorer allows devices to be added to the Site specified in the top left corner of the Cylon BACnet Explorer dialog (which may be an existing Site or a new Site that will be created when devices are added).

To add devices to the selected Site, check the box beside each required device in the Site Tree and click on the **Add Selected Devices to Site** button. To quickly select all of the discovered devices check the **Select all devices to add to Site** box beneath the Site Tree. Non-Cylon devices will be added as virtual controllers and have a **Unitron** address of 131 or above.

**Note:** A selected device will only be added to the Site if all of its information has been successfully read from the network. On a large Site, it is possible that a device may have responded with an I-Am, but that there was not enough time to request other information (Name, model etc.). If this is the case the Site can be rescanned or the information can be entered manually.

## Device List

When the root of the tree view is selected, the right panel contains a list of the BACnet devices found, along with: device name, MAC address, vendor ID, model name, IP or MSTP Address, Network and estimated Controller Type.

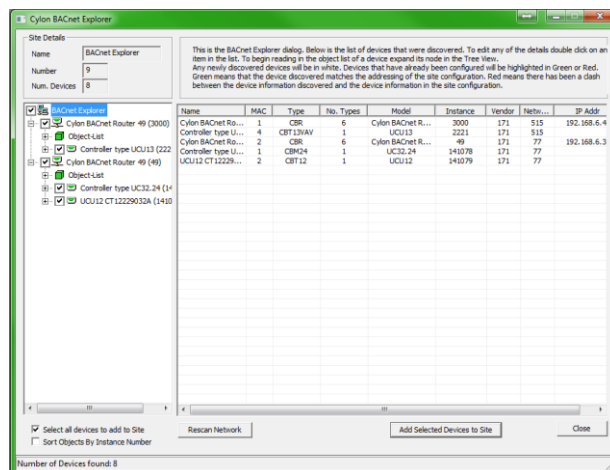

There is also a column (**No. Types**) which shows the number of possible Cylon controller types this device could be.

The Explorer tries to establish the correct **Type** for Cylon devices. If the correct **Type** cannot be determined then it can be set manually in the **Controller Properties** dialog. The **Type** of a non-Cylon device cannot be changed in the **Controller Properties** dialog, but if they are added to the Site, they will appear as **CBM24** in the **Engineering Center**, and this can be changed in the **Configuration utility (CCConfig)**.

To open the **Controller Properties** dialog, double-click on the device in the right-hand panel.

## ABB Cylon® BACnet | Configuring the Cylon BACnet System

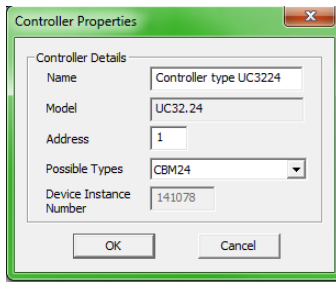

Controller Properties for a Cylon device

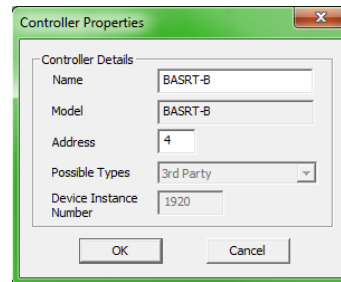

Controller Properties for a Non-Cylon device

You can then change the **Name**, **Type** (for Cylon Controllers), and **Address** before adding them to the Site.

**Note:** This will only change the name of the device in the database on the PC - it will not change the name on the device itself.

When the device node of the tree is expanded or double-clicked, the object list of that device will be read in. As each object is received from the device it will be added as a child to that device node. At this stage the right-hand panel will display the object list with a column for **object ID**, **object type**, **object name**, and **present value** and this list will be populated as objects are read in.

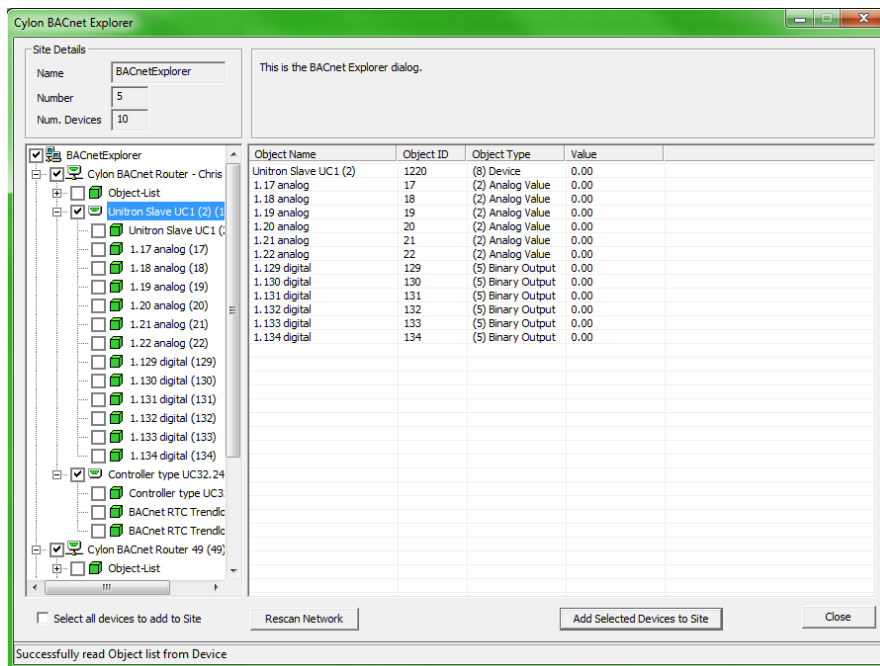

When an object is selected in the tree view, the properties of that object will be read from the device and the right-hand panel will contain the properties and values of that object.

**Note:** To refresh a specific object, right-click on that object.

### Check Against Existing Devices

When using the **BACnet Explorer** on an existing Site, any discovered devices must be checked against those that have already been configured. This is done by comparing the Device Instance Number of each discovered device against the Device Instance Number of any devices on the Site configuration already.

For any discovered devices that have the same Device Instance Number as a device on the PC, there will be a comparison made between the MAC address discovered and the **Unitron** address.

- If these match, the device will be highlighted in the list in green to signify that the devices match. A matching device cannot be edited.
- If they do not match, then the device in the list control will be highlighted in red to alert the user to this mismatch. The user will be given a choice to resolve the mismatch
- If the Device Instance Number does not match any other ID on the PC, then this discovered device will not be highlighted and will be left white. Non-matching devices can be edited.
- If a device exists in the local Site configuration but no I-Am is received from it, it will be highlighted in gray in the results dialog.



## BUILDING A STRATEGY

### OVERVIEW

This section covers some of the modules (blocks) that can be used in **Cylon BACnet** strategies. The **Engineering Center** divides the Strategy modules into the following categories:

- Points
- Logic
- Mathematical
- Control
- Function
- Statistic

When you choose a particular module group, the modules within that group are presented in the modules bar. The modules bar is usually docked below the Toolbar, but can be resized and moved to any location on screen.

For example if the P group is selected:

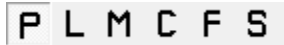

then the Points modules bar is displayed:



The BACnet-specific modules covered in this section are:

- BACnet Alarms
- BACnet Trendlogs
- BACnet Schedules
- BACnet 3<sup>rd</sup> Party Points
- BACnet Priority Array

## “POINTS” AND POINT NUMBERS

In the **Cylon Engineering Center**, the connections between modules are referred to as ‘points’. These Strategy Points can represent physical inputs and outputs on a Controller, or Analog/Binary values (referred to in the **Engineering Center** as ‘Virtual Points’).

Each Analog Input, Analog Output, Binary Input, Binary Output, Analog Value and Binary Value is assigned a number:

Controller terminals (i.e. inputs and outputs) - “hardware points” in the **Engineering Centre** - are assigned numbers between 1 and 24. Each terminal can be either an input or an output, so that there cannot be two hardware points with the same number. For example if there is an Analog Input 3 there cannot be an Analog Output 3 or Binary Input 3 at the same time.

**Note:** In theory hardware point numbers could be up to 1024, but is limited by the Controller hardware so that the current maximum is 24.

Analog Values (“Analog virtual points”) can be numbered 1-1024, and Binary Values (“Digital virtual points”) can be numbered 1 – 1024, so that there could be for example both Analog Value 3 and Binary Value 3.

**Note:** The combined number of Analog Values and Binary Values that can be exposed on a BACnet network by a single **CBM** or **CBT** is 225. As a result, it is important to keep the total number of defined setpoints in a Strategy below this value.

In Strategy drawings generated by the **Engineering Center**, it is possible to identify a Strategy Point’s nature as follows:

- If the number has brackets around it it is a “hardware point” – Analog Input, Analog Output, Binary Input or Binary Output.
- If the number is not bracketed, but is connected to a circular connection point, it is an Analog Value (“analog virtual point”).
- If the number is not bracketed, but is connected to a square connection point, it is a Binary Value (“digital virtual point”).

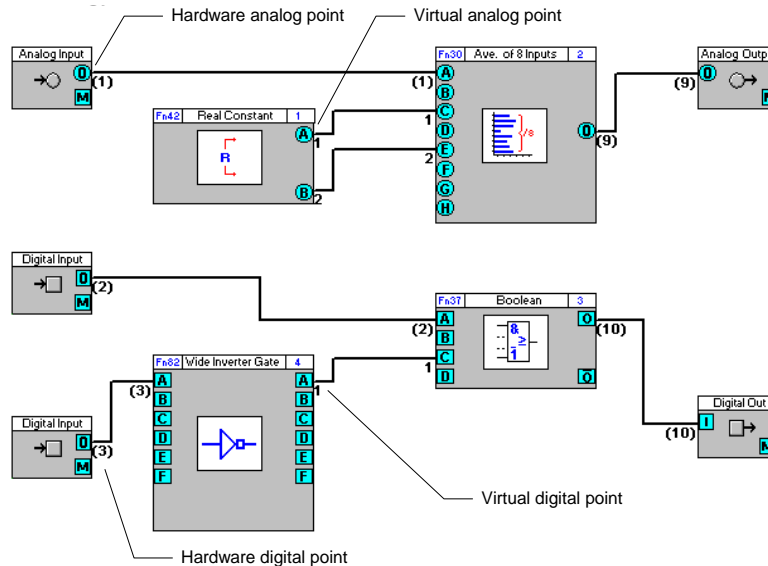

## BACNET TIME SCHEDULE

### APPEARANCE

Group



(Logic)

Button



Symbol

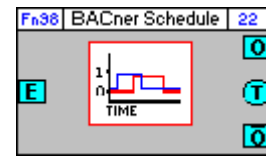

Dialog box

BACnet Time Schedule

Block Number: 22
Time Schedule Name: Schedule No. 2

**Inputs**

| Name           | Pt No. | Value |
|----------------|--------|-------|
| Enabling Point | 0      | OFF   |

**Constants**

Write Priority

Times:

|        | Monday                           |        | Tuesday                          |        | Wednesday                        |        | Thursday                         |        | Friday                           |        | Saturday                         |        | Sunday                           |        |
|--------|----------------------------------|--------|----------------------------------|--------|----------------------------------|--------|----------------------------------|--------|----------------------------------|--------|----------------------------------|--------|----------------------------------|--------|
|        | Hour                             | Minute | Hour                             | Minute | Hour                             | Minute | Hour                             | Minute | Hour                             | Minute | Hour                             | Minute | Hour                             | Minute |
| Start: | 09                               | 00     | 09                               | 00     | 09                               | 00     | 09                               | 00     | 09                               | 00     | 09                               | 00     | 09                               | 00     |
| Stop:  | 17                               | 00     | 17                               | 00     | 17                               | 00     | 17                               | 00     | 17                               | 00     | 17                               | 00     | 17                               | 00     |
|        | <input type="checkbox"/> On All  |        | <input type="checkbox"/> On All  |        | <input type="checkbox"/> On All  |        | <input type="checkbox"/> On All  |        | <input type="checkbox"/> On All  |        | <input type="checkbox"/> On All  |        | <input type="checkbox"/> On All  |        |
|        | <input type="checkbox"/> Off All |        | <input type="checkbox"/> Off All |        | <input type="checkbox"/> Off All |        | <input type="checkbox"/> Off All |        | <input type="checkbox"/> Off All |        | <input type="checkbox"/> Off All |        | <input type="checkbox"/> Off All |        |

**Outputs**

| Name           | Pt No. | Value |
|----------------|--------|-------|
| True Output    | 0      | OFF   |
| Complement     | 0      | OFF   |
| Secs to change | 0      |       |

< > OK Cancel

### FUNCTION

The BACnet Time Schedule block allows the user to pre-load a single start time and a single stop time for each day of the week to be used in a locally-hosted BACnet weekly schedule.

If the module is enabled, then when the controller's clock registers a time between the start and stop time on each day, the output of the module will be "1", and outside of those times it will be "0".

This module accepts one input, which enables/disables the operation of the module, but leaving this input unattached will allow the schedule to run normally.

The module produces three outputs: the present value of the schedule, the inverse of the present value and the number of seconds until the next scheduled change.

## PARAMETERS

### Time Schedule Name

User defined name for the BACnet schedule object.

### Inputs

| Parameter Name        | Description   |
|-----------------------|---|
| <b>Enabling Point</b> | Displays the number of the digital point that is connected to the enabling input (“E”) of the block. If the digital point is true the time schedule is enabled and will output accordingly, if the point is false then the block will output false. |

### Constants

| Parameter Name        | Description   |
|-----------------------|---|
| <b>Write Priority</b> | The priority at which the BACnet time schedule block will write at. By default this is set to 16. |
| <b>Times</b>          | The days of the week and times between which the schedule will start and stop.                    |

### Outputs

| Parameter Name        | Description   |
|-----------------------|---|
| <b>True Output</b>    | The current status of the schedule.                           |
| <b>Compliment</b>     | The inverse of the current schedule status.                   |
| <b>Secs to change</b> | The number of seconds remaining until the output will change. |

### How to add a BACnet Time Schedule to a Strategy.

When the BACnet Schedule is initially added to the Strategy and linked to another Strategy block it will take the name of the point created when the blocks are connected. In the example below the point has been named “DigVirt\_1”.

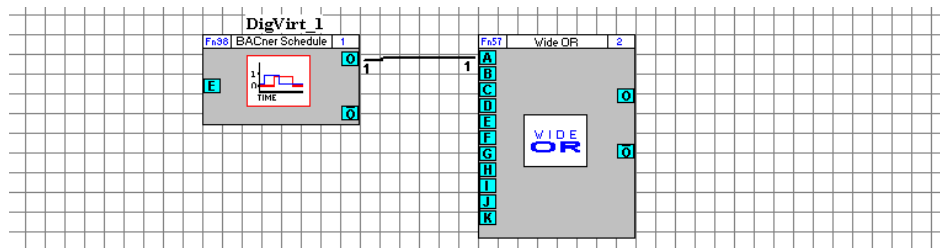

To rename the BACnet schedule, the point must be renamed. To do this simply right click on the output of the block and select **Edit Point**.

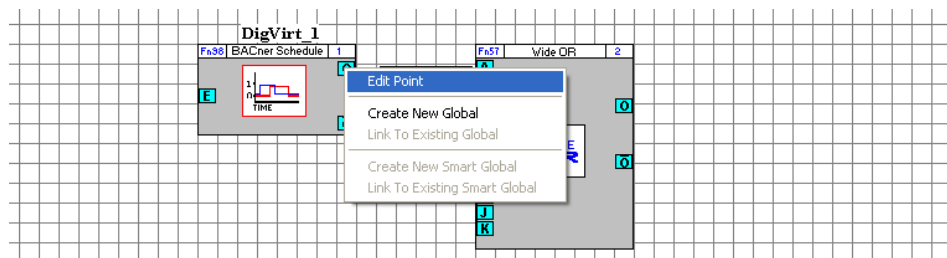

# ABB Cylon® BACnet | Configuring the Cylon BACnet System

This opens the point's dialog box, which allows the point name to be changed. In the example below the point has been renamed to "Time Schedule".

At the same time the BACnet Time Schedule has also taken the name of the point:

When downloaded to the controller, and viewed with a BACnet browser, the BACnet properties show the time schedule as a BACnet object.

| Property                           | Value         |
|------------------------------------|---------------|
| object-identifier                  | PO-1 (0x04... |
| object-type                        | PO (17)       |
| object-name                        | Time Sche...  |
| present-value                      | 1             |
| priority-for-writing               | 16            |
| status-flags                       | Double-clc... |
| reliability                        | Unknown ...   |
| out-of-service                     | FALSE         |
| effective-period                   | * * * * *     |
| exception-schedule                 |               |
| weekly-schedule                    | Double-clc... |
| list-of-object-property-references | Double-clc... |
| schedule-default                   | FALSE         |

## BACNET ALARM BLOCK

**Note:** This strategy-based method for generating binary alarms has been made redundant by the alarming functionality now native in all Inputs, Values and Outputs. This block has been left in place to support existing strategies that use this block, but should not be used in a new Strategy.

### Appearance

#### Group

**S** (Statistic)

#### Button



#### Symbol

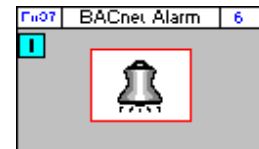

### Dialog box

Block Number: 
Alarm Name:

| <i>Inputs</i> |        |       | <i>Constants</i>   |  | <i>Outputs</i> |        |       |
|---------------|--------|-------|--|--|----------------|--------|-------|
| Name          | Pt No. | Value |  |  | Name           | Pt No. | Value |
| Alarm Point   | 0      | OFF   | Alarm Data<br>Notification Class: <input type="text" value="1"/><br>Time Delay: <input type="text" value="2"/><br>Active Text: <input type="text"/><br>Inactive Text: <input type="text"/> |  |                |        |       |
|               |        |       | <input type="checkbox"/> Generate Alarm On<br><input checked="" type="radio"/> High Value<br><input type="radio"/> Low Value   |  |                |        |       |
|               |        |       | <input type="checkbox"/> Notify Type<br><input checked="" type="radio"/> Alarm<br><input type="radio"/> Event  |  |                |        |       |

### Function

Alarms are used in a BMS system to alert site supervisors/engineers to any difficulties that may occur on a Site. The **Cylon BACnet** range supports BACnet Alarm notifications which can be made available to BACnet supervisors.

The BACnet Alarm module is joined to a digital point (Binary Value). When the digital point has the value 1, the BACnet Alarm module is activated. The Binary Value may indicate an error condition, for example a sensor going out of normal range or a fire alarm being activated.

## Parameters

### Alarm Name

A name assigned by the user to identify the BACnet Alarm object.

### Inputs

| Parameter Name     | Description   |
|--------------------|---|
| <b>Alarm Point</b> | This displays the digital point number that is connected to the input of the block. |

### Constants

| Parameter Name            | Description  |
|---------------------------|--|
| <b>Notification Class</b> | The alarm can be assigned a number through this parameter. This can be useful when grouping alarms.  |
| <b>Time Delay</b>         | The time delay that the block waits before making the alarm active or inactive.  |
| <b>Active Text</b>        | The text that is displayed on the supervisor software when the alarm is active.  |
| <b>Inactive Text</b>      | The text that is displayed on the supervisor software when the alarm is inactive.  |
| <b>Generate Alarm On</b>  | This option can be set to high value or low value by the user. <ul style="list-style-type: none"> <li>• If set to a high value, then the alarm will be active when the input is true.</li> <li>• If set to a low value, the alarm will be active when the input is false.</li> </ul> |
| <b>Notify Type</b>        | Notify Type is a standard BACnet property, which can be set to either "Alarm" or "Event". This can be used to categorize alarms, if a Site requires it.  |

## BACNET TRENDLOG BLOCK

### Appearance

#### Group

**S** (Statistic)

#### Button



#### Symbol

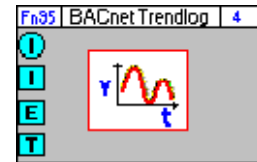

### Dialog box

Block Number: 
Trendlog Description:

| <b>Inputs</b>     |        |       | <b>Constants</b>   |  |  | <b>Outputs</b> |        |       |
|-------------------|--------|-------|--|--|--|----------------|--------|-------|
| Name              | Pt No. | Value |  |  |  | Name           | Pt No. | Value |
| Analog Log Point  | 1      |       | Trendlog Number: <input type="text" value="1"/><br>Trendlog Point Type: <input type="text" value="Analog"/><br>When to log the value<br><input checked="" type="radio"/> Log at fixed intervals of<br><input type="text" value="900"/> seconds<br><input type="radio"/> Log when value changes by<br><input type="text" value="1.000000"/> units<br><input type="button" value="Advanced Options..."/> |  |  |                |        |       |
| Trendlog Enable   | 0      | OFF   |  |  |  |                |        |       |
| Log Trigger Point | 0      | OFF   |  |  |  |                |        |       |

### Function

BACnet Trend Logs, similar to **Unitron** Datalogs, allow point values in a Controller to be recorded over a period of time. For example, a Trend Log on an output point could monitor valve positions, or a Trend Log on an input could log outside air temperature.

The input point value can be logged either at regular intervals or when the value changes by a defined amount.

The recorded data can be later retrieved, displayed and analyzed with the **Datalog Manager** application.

The number of Trend Logs that can be added to a Strategy depends on the Controller on which the Strategy runs. For example a **CBM24** can have up to 32 Trend Logs and a **CBT12iVAV** can have up to 4.

**Note:** To find out the maximum number of Trend Log that a Strategy can support, open the Strategy, select View > Managers and open the Resources tab in the Managers dialog.

## PARAMETERS

### Datalog Description

A name assigned by the user to identify the BACnet Trend Log object.

### Inputs



| Parameter Name           | Description   | Possible Values |
|--------------------------|---|-----------------|
| <b>Analog Log Point</b>  | The point number and value of the point being logged if the module's Analog input is connected to an analog point.<br><i>Note: Only one of the input points can be connected, so only the connected one is displayed in the dialog's input column.</i>  | Real number     |
| <b>Digital Log Point</b> | The point number and value of the point being logged if the module's Digital input is connected to a digital point.<br><i>Note: Only one of the input points can be connected, so only the connected one is displayed in the dialog's input column.</i> | Booolean        |
| <b>Trendlog Enable</b>   | The point number and current values of the enabling point for this module. When the value of this point is "1", the "Log Point" will be logged.   | 1 or 0          |
| <b>Log Trigger Point</b> | Data is recorded when this trigger point changes. If the trigger point is not connected, logging occurs according to the ' When to log the value ' parameters below.  | 1 or 0          |

### Constants

| Parameter Name  | Description   | Possible Values  |
|---|---|--|
| <b>Trendlog Number</b>                                  | This field displays the number used by the <b>Datalog Manager</b> application to access the data collected by this module.  | Depends on controller type   |
| <b>Trendlog Point Type</b>                              | This field displays the type of point that this module is logging.  | "Analog" or "Digital"  |
| <b>When to log the value: Log at fixed intervals of</b> | When this option is selected the seconds input box becomes editable, and the value of the Log Point will be recorded at regular intervals.  | Integer (number of seconds)  |
| <b>When to log the value: Log when value changes by</b> | When this option is selected the units input box becomes editable, and the value of the Log Point will be whenever that Log Point value changes by an amount greater than the number of units specified.  | Integer (number of units)  |
| <b>Advanced Options</b>                                 | The Advanced Options button becomes available when the module's Log Trigger Point input (the "T" input) is connected to a digital point. This digital point can be, for example, an alarm arising, a switch being thrown, a window opening etc. When this input is connected, the Trend Log will log when the state of this input changes. Clicking on the Advanced Options button opens the Datalog Advanced Options dialog box: | Any Edge, i.e. every time the trigger point changes state.<br>Rising Edge, i.e. when the value of the trigger point changes from 0 to 1.<br>Falling Edge, i.e. when the values of the trigger point changes from 1 to 0. |

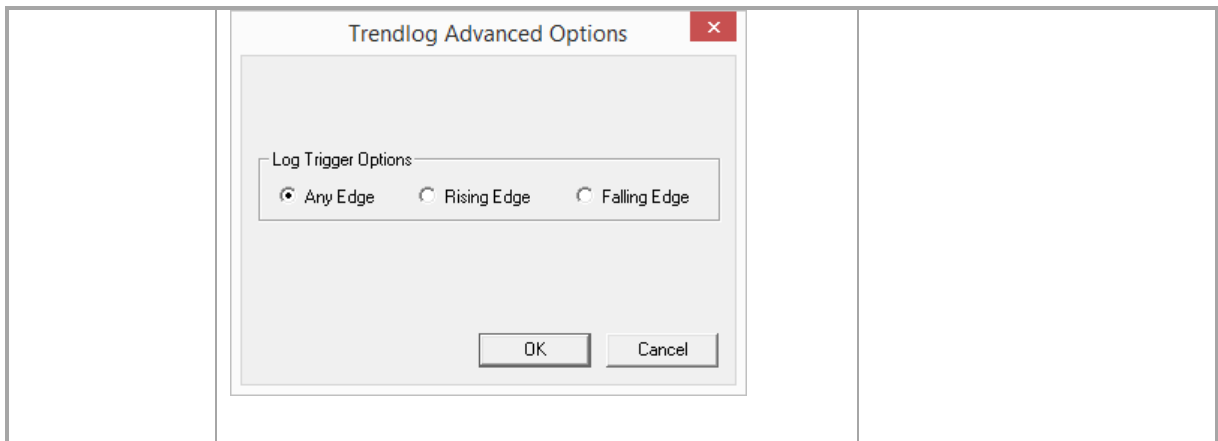

### How to set up a BACnet Trendlog

In the case of the Strategy below a **BACnet Trend Log** block has been attached to a hardware point that measures temperature. The hardware point has been named “Room Temperature” and so the **BACnet Trend Log** block has taken the same name.

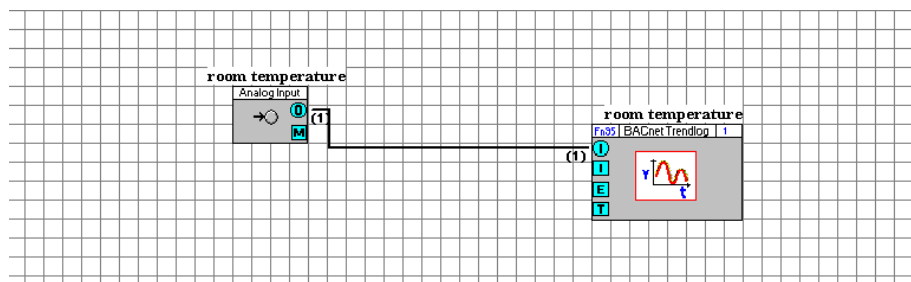

Right-clicking on the block opens the properties dialog box.

### Trendlog Read Performance

It is possible to optimize the way **BACnet Trend Log** data is read by the front-end Workstation.

For example, altering the number of records that are accessed per request changes the number of records the Controller can return each time it obtains the network token. A request for up to 20 records at a time is optimal for loading an MS/TP packet.

Front-end Workstations can also be configured to request only new records from the Controller, which can improve the performance of the system.

## 3<sup>RD</sup> PARTY POINT BLOCKS – [3<sup>RD</sup> PARTY ANALOG] AND [3<sup>RD</sup> PARTY BINARY]

### Appearance

#### Group



#### Button



#### Symbol

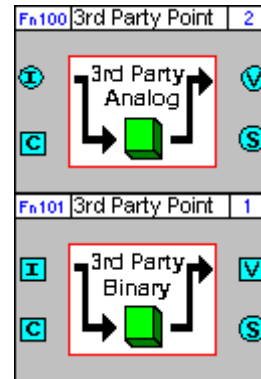

### Dialog box

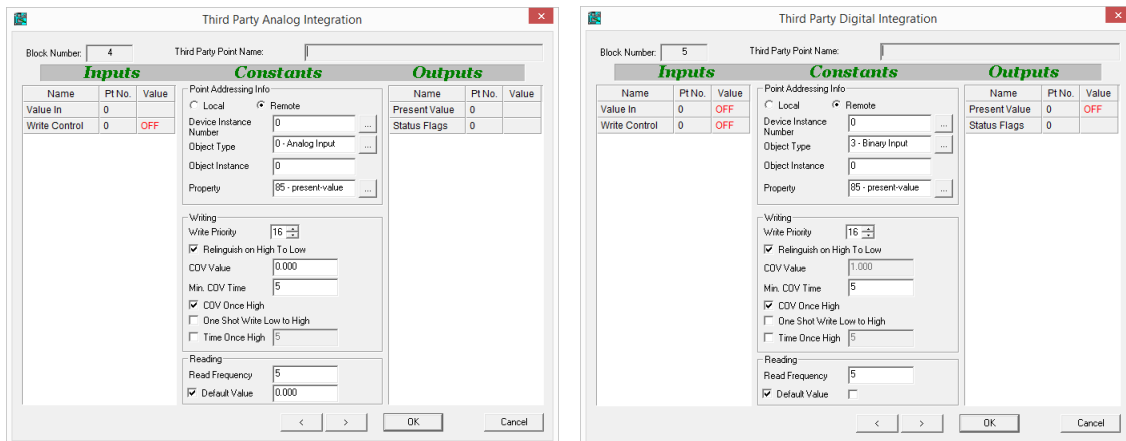

### Function

The 3<sup>rd</sup> party point blocks provide a mechanism for reading and writing values from and to a third party device directly in a Strategy. The same mechanism can be used to also be used to access BACnet objects within the local Strategy if required.

There are two separate “3<sup>rd</sup> Party point” blocks – one that is used to move data to and from analog Strategy block connections and one that is used to move data to and from binary Strategy block connections.

Both types of 3<sup>rd</sup> party blocks can access the same BACnet data, which is automatically converted to the appropriate data type as the data is pulled from or pushed to the network.

## Parameters

### Time Schedule Name



User defined name for the BACnet schedule object.

### Inputs

| Parameter Name       | Description   |
|----------------------|---|
| <b>Value in</b>      | This is the value that will be written to the 3rd-party device. If the analog 3rd-party block is being used then an analog point must be linked to this input and if the digital 3rd-party block is being used then a digital point must be linked to this input. |
| <b>Write Control</b> | This is a digital input which when set to 'On' allows the value of the <b>Value In</b> input to be written to the 3rd party object, subject to the settings in the <b>Constants &gt; Writing</b> section of the dialog.   |

## Constants

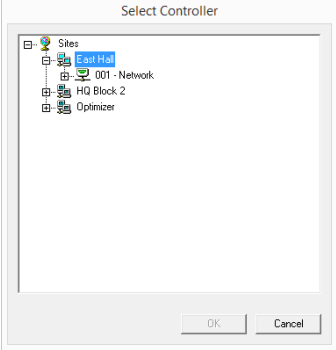
### Point Addressing Info

| Parameter Name                | Description   |
|-------------------------------|---|
| <b>Local/Remote</b>           | This defines whether the '3rd-party' object to which this block refers is actually in the same Strategy as the block (i.e. in the "Local" device) or in a different device ("Remote"). If the block is copy and pasted into a different Strategy, it will remain connected to the same point if this parameter is set to "Remote". If this parameter is set to "Local" the pasted block will try to access a point within its new Strategy that matches the <b>Object Type</b> and <b>Object Instance</b> settings.   |
| <b>Device Instance Number</b> | This is the Device Instance Number of the third-party device that will be read from or written to. It is only available if <b>Local/Remote</b> is set to "Remote". <div style="border: 1px solid gray; padding: 5px; margin: 10px 0;"> <p><b>Note:</b> You can type any number in this input, but a Site Tree is available by clicking the  button to the right of the input field:</p> </div>  |
| <b>Object Type</b>            | Any BACnet Object Type can be entered in this field. It is used together with <b>Object Instance</b> to specify the object which will be read or written. <p><b>Note:</b> You can type any number in this input, but a list of common Object Types is available by clicking the  button to the right of the input field.</p>   |
| <b>Object instance</b>        | This is the instance number within the selected <b>Object Type</b> that specifies the object which is to be read or written.  |
| <b>Property</b>               | This is the BACnet property of the specified object that is to be read or written. Defaults to 85-present-value. <p><b>Note:</b> You can type any number in this input, but a list of common BACnet Properties is available by clicking the  button to the right of the input field.</p>   |

## ABB Cylon® BACnet | Configuring the Cylon BACnet System

### Writing

These constants determine when the input value will be written to the third-party device, and the priority in that device's priority array to which the value will be written.

If the block is writing to but not reading from the third-party device, then only the input needs to be connected.

| Parameter Name                    | Description  |
|-----------------------------------|--|
| <b>Write Priority</b>             | This is the element in the third-party device's Priority Array to which the input value will be written. By default the value is priority 16 (i.e. lowest priority), but it can be set in the range 1-16.  |
| <b>Relinquish on High to Low</b>  | If this box is checked, the controller will relinquish the Priority Array element set in the Write Array constant (i.e. set it to null) when the Write Control input goes from high to low.  |
| <b>COV Value</b>                  | If this constant is set, then writing will only take place if the Value In value changes by the amount specified here during the time period specified in Min. COV Time.   |
| <b>Min. COV Time</b>              | In order to avoid a continuously-changing Value In value generating too much traffic on the BACnet system, you can limit how often the value is sent to the third-party object by setting a minimum time between sends here.<br>This value is the number of seconds between sends. |
| <b>COV Once High</b>              | If this box is checked, the controller will write to the third-party device only if the Write Control is set to ON and the Value In changes by the COV value.  |
| <b>One Shot Write Low to High</b> | If this box is checked, the controller will write the current Value In value to the third-party device when the Write Control changes from OFF to ON.  |
| <b>Time Once High</b>             | If the check box in this parameter is checked, the controller will write the Value In value to the third-party device repeatedly at the frequency set in the parameter's value box. By default this is set to 5 seconds.   |

### Constants – Reading

These constants determine how often the Present Value of the third-party object will be read and sent to the block's output.

If the block is reading from but not writing to the third-party device, then only the output needs to be connected.

| Parameter Name        | Description  |
|-----------------------|--|
| <b>Read Frequency</b> | This is the number of seconds between reads. By default this is set to 5 seconds.  |
| <b>Default Value</b>  | If the check box in this parameter is checked and if the third-party device cannot be read, the output of the block will be set to the value in this parameter's value box.<br>The value box for Binary third-party points is a checkbox. If it is checked the output will be set to "On", if not the output will be set to "Off". |

**Outputs**

| Parameter Name       | Description   |  |  |           |           |       |         |                      |                              |       |                       |  |  |       |                         |                             |  |       |                       |                      |                             |       |                     |  |  |
|----------------------|---|--|--|-----------|-----------|-------|---------|----------------------|------------------------------|-------|-----------------------|--|--|-------|-------------------------|-----------------------------|--|-------|-----------------------|----------------------|-----------------------------|-------|---------------------|--|--|
| <b>Present Value</b> | <p>The present value of the BACnet object is written to this output.</p> <p>If the present value cannot be read, and the <b>Constants &gt; Default Value</b> is enabled, this output is set to the Default value.</p> <p>If the present value cannot be read, and the <b>Constants &gt; Default Value</b> is disabled, then this output remains at its previous value.</p>  |  |  |           |           |       |         |                      |                              |       |                       |  |  |       |                         |                             |  |       |                       |                      |                             |       |                     |  |  |
| <b>Status Flag</b>   | <p>This is an analog value that represents a 5 bit array, which contains information about the status of communications with the third-party device.</p> <table border="1"> <thead> <tr> <th></th> <th>Function</th> <th>Value = 0</th> <th>Value = 1</th> </tr> </thead> <tbody> <tr> <td>Bit 0</td> <td>Problem</td> <td>No problem detected.</td> <td>A problem has been detected.</td> </tr> <tr> <td>Bit 1</td> <td>Failure to send write</td> <td>Data written to 3<sup>rd</sup> party device ok.</td> <td>Write to 3<sup>rd</sup> party device failed</td> </tr> <tr> <td>Bit 2</td> <td>Failure to RX write ACK</td> <td>Acknowledgement received ok</td> <td>No acknowledgement when writing to 3<sup>rd</sup> party</td> </tr> <tr> <td>Bit 3</td> <td>Failure to send read.</td> <td>Read request sent ok</td> <td>Failed to send read request</td> </tr> <tr> <td>Bit 4</td> <td>Failure to RX read.</td> <td>Data read from 3<sup>rd</sup> party device ok</td> <td>No data received from 3<sup>rd</sup> party device</td> </tr> </tbody> </table> |  | Function   | Value = 0 | Value = 1 | Bit 0 | Problem | No problem detected. | A problem has been detected. | Bit 1 | Failure to send write | Data written to 3 <sup>rd</sup> party device ok. | Write to 3 <sup>rd</sup> party device failed | Bit 2 | Failure to RX write ACK | Acknowledgement received ok | No acknowledgement when writing to 3 <sup>rd</sup> party | Bit 3 | Failure to send read. | Read request sent ok | Failed to send read request | Bit 4 | Failure to RX read. | Data read from 3 <sup>rd</sup> party device ok | No data received from 3 <sup>rd</sup> party device |
|                      | Function  | Value = 0  | Value = 1  |           |           |       |         |                      |                              |       |                       |  |  |       |                         |                             |  |       |                       |                      |                             |       |                     |  |  |
| Bit 0                | Problem   | No problem detected.                             | A problem has been detected.                             |           |           |       |         |                      |                              |       |                       |  |  |       |                         |                             |  |       |                       |                      |                             |       |                     |  |  |
| Bit 1                | Failure to send write   | Data written to 3 <sup>rd</sup> party device ok. | Write to 3 <sup>rd</sup> party device failed             |           |           |       |         |                      |                              |       |                       |  |  |       |                         |                             |  |       |                       |                      |                             |       |                     |  |  |
| Bit 2                | Failure to RX write ACK   | Acknowledgement received ok                      | No acknowledgement when writing to 3 <sup>rd</sup> party |           |           |       |         |                      |                              |       |                       |  |  |       |                         |                             |  |       |                       |                      |                             |       |                     |  |  |
| Bit 3                | Failure to send read.   | Read request sent ok                             | Failed to send read request                              |           |           |       |         |                      |                              |       |                       |  |  |       |                         |                             |  |       |                       |                      |                             |       |                     |  |  |
| Bit 4                | Failure to RX read.   | Data read from 3 <sup>rd</sup> party device ok   | No data received from 3 <sup>rd</sup> party device       |           |           |       |         |                      |                              |       |                       |  |  |       |                         |                             |  |       |                       |                      |                             |       |                     |  |  |

## PRIORITY ARRAY BLOCKS – [ANLG PA] AND [BNRY PA]

**Note:** This strategy-based method for generating Priority Arrays has been made redundant by the Priority Array functionality now native in all Value and Output objects. This block has been left in place to support existing strategies that use this block, but should not be used in a new Strategy.

### Appearance

#### Group



(Points)

#### Button



#### Symbol

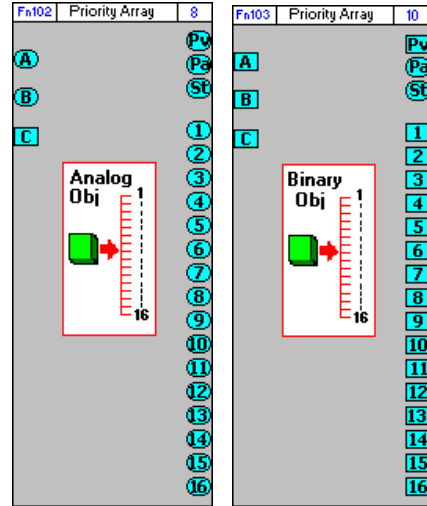

### Dialog box

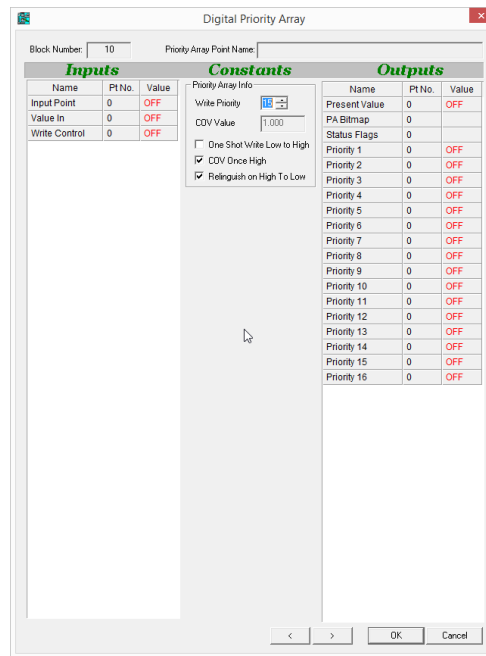
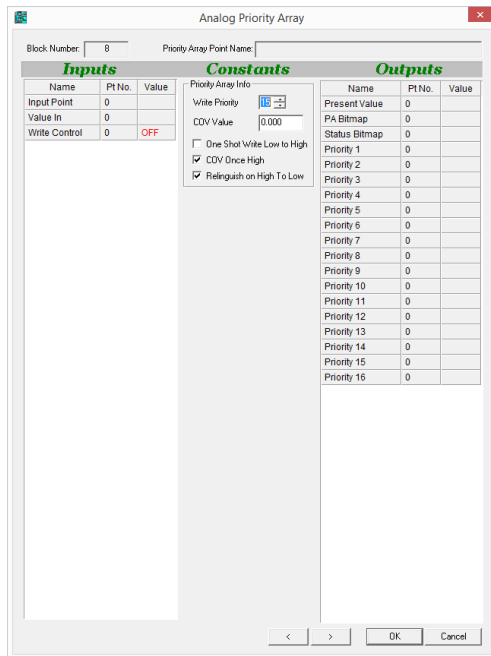

### Function

BACnet value objects and BACnet output objects use a Priority Array to determine their value. Each element in the array will either have a value or be set to `null`. The 'present value' of the object is set to match the the highest priority element in the array that has a valid value.

The priority array blocks provide a method of assigning a value to an element in the Priority Array of a specific BACnet object.

There are two priority array blocks in the **Cylon Engineering Center**:

- **Priority Array Analog Object** for setting a value in the array of an Analog Value, or an Analog Output.
- **Priority Array Digital Object** for setting a value in the array of a Binary Value, or a Binary Output.

If a point is connected to the block's **Input Point (A)** then the block will show the Priority Array of that point.

If the block's **Input Point (A)** is unattached then the block will show the Priority Array of the point connected to the **Present Value output (Pv)**.

**Note:** If neither point is connected the block will not function, and a warning message will be displayed: **Strategy Warning - Analog Priority Block is inoperable as it is not attached to any BACnet points.**

The value of a single element of the array is set to match the value of the **Value In (B)** input when permitted to do so by the **Write Control (C)** input. The element to be set is defined by the **Write Priority** constant.

If the BACnet object to be affected is a BACnet Output object, the input of that object's module in the Strategy drawing must be connected to the output of the priority array block that matches the **Write Priority** setting.

If the object to be affected is a BACnet Value object, then the output of that object's module in the Strategy drawing must be connected to the **Input Point (A)**.

The main use of the **Priority Array** block is to quickly and easily conditionally override outputs or values.



## Parameters

### Inputs

| Parameter Name       | Description  |
|----------------------|--|
| <b>Input Point</b>   | This is the point representing the BACnet object whose Priority Array will be affected by the Priority Array block.  |
| <b>Value In</b>      | This is the value to which the selected priority element in the Priority Array will be set.  |
| <b>Write Control</b> | This is a digital input which when set to 'On' allows the value of the Value In input to be written to the Write Priority element, subject to the settings in the Constants section of the dialog. |

### Constants

| Parameter Name                    | Description  |
|-----------------------------------|--|
| <b>Write Priority</b>             | This is the Priority number of the element in the Priority Array that will be set. By default the value is priority 15 however it can be set in the range 1-16.                            |
| <b>COV Value</b>                  | If the COV Once High property is set, then the relevant element in the Priority Array will be set if the Value In input changes by more than the value set here in the COV Value property. |
| <b>One Shot Write Low to High</b> | If this box is checked then the relevant element in the Priority Array will be set to match the Value In input when the write control input goes from low to high.                         |
| <b>COV Once High</b>              | If this box is checked the relevant element in the Priority Array will be set to match the Value In input when than value changes by more than the amount set in the COV Value property.   |
| <b>Relinquish on High to Low</b>  | If this box is checked then the relevant element in the Priority Array will be set to Null when the Write Control input goes from high to low.   |

### Outputs

| Parameter Name                      | Description  |
|-------------------------------------|--|
| <b>Present Value</b>                | This output matches the 'Present Value' of the BACnet object associated with the Input Point.  |
| <b>PA Bitmap</b>                    | This an analog value that represents a 16 bit array, each bit representing the override status of each element in the priority array. If a specific priority has been overwritten, the bit in the PA bitmap corresponding to that element will be set to 1.  |
| <b>Status Bitmap / Status Flags</b> | This output is not currently used.   |
| <b>Priority 1-16</b>                | <p>These outputs give access to the values at each priority for the BACnet object. These outputs could be connected to a Strategy that contains logic to address control situations that depend on BACnet priorities.</p> <p><b>Note:</b> If a priority becomes set to a "null" value through BACnet, then the related output will remain set to the last non-null value of that priority.</p> |

## BACKING UP THE BACNET SITE

The **Cylon Engineering Centre** software uses data files organized on the PC in a directory structure representing the structure of the Site. This directory structure can be archived, and installed on another PC or restored to the original PC.

The **Site Backup Utility (CCBackup)**, automates the archiving and the restoring processes – see *MAN0072 Site Backup Utility*. However it does not include **CBR** configurations in those processes.

## BACKING UP THE CBR ROUTERS

Each **CBR** on a Site must be individually backed up as follows:

Right-click on the **CBR** in the **Cylon Engineering Center's** Site Tree, and select **Backup Router**:

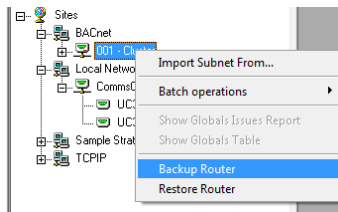

The Router Backup dialog will open:

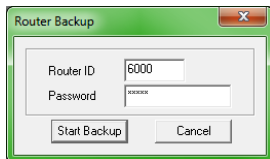

Enter a valid BACnet Device Instance Number and the router's password

**Note:** The router's password is the one that is used to access the Configuration web interface of the router. It can be set or changed from the router's Configuration web interface.

Click the **Site Backup** button

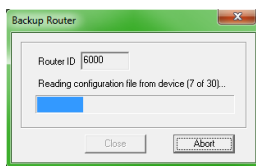

The backup file for this router will be stored in Site's **RouterBackups** directory:

| Name | Date modified    | Type   | Size  |
|------|------------------|--------|-------|
| 1.d  | 17/06/2013 11:16 | D File | 2 KB  |
| 2.d  | 17/06/2013 11:16 | D File | 2 KB  |
| 3.d  | 17/06/2013 11:16 | D File | 1 KB  |
| 4.d  | 17/06/2013 11:16 | D File | 1 KB  |
| 5.d  | 17/06/2013 11:16 | D File | 6 KB  |
| 6.d  | 17/06/2013 11:16 | D File | 4 KB  |
| 7.d  | 17/06/2013 11:16 | D File | 27 KB |
| 8.d  | 17/06/2013 11:16 | D File | 1 KB  |
| 9.d  | 17/06/2013 11:16 | D File | 65 KB |
| 10.d | 17/06/2013 11:17 | D File | 66 KB |
| 11.d | 17/06/2013 11:17 | D File | 66 KB |
| 12.d | 17/06/2013 11:17 | D File | 4 KB  |
| 13.d | 17/06/2013 11:17 | D File | 2 KB  |
| 14.d | 17/06/2013 11:17 | D File | 2 KB  |
| 15.d | 17/06/2013 11:17 | D File | 3 KB  |

## HOW TO RESTORE A CBR ROUTER

To restore a router from a backup,

# ABB Cylon® BACnet | Configuring the Cylon BACnet System

Right-click on the **CBR** in the **Cylon Engineering Center's** Site Tree, and select **Restore Router**.

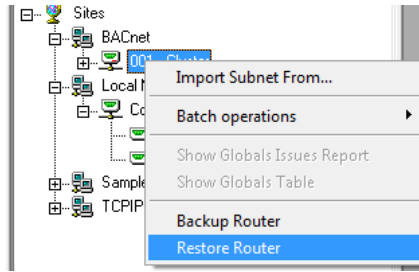

The **Password** dialog will open.

Enter the Device Instance Number of the router to be restored and the router's password

**Note:** The router's password is the one that is used to access the Configuration web interface of the router. It can be set or changed from the router's Configuration web interface.

The **Restore Router** dialog will open:

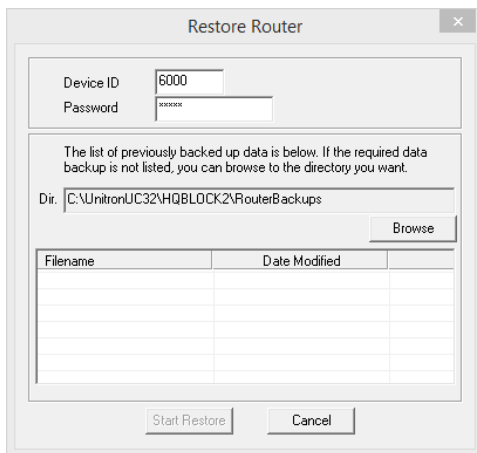

Click on the **Browse** button and select the location of the backup that is to be restored:

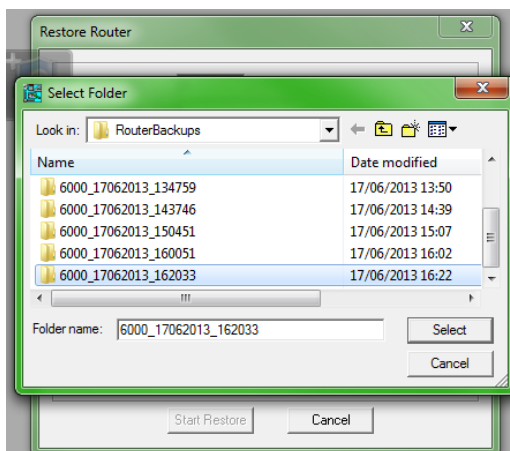

The files that comprise the backup will be displayed with their modified date:

## ABB Cylon® BACnet | Configuring the Cylon BACnet System

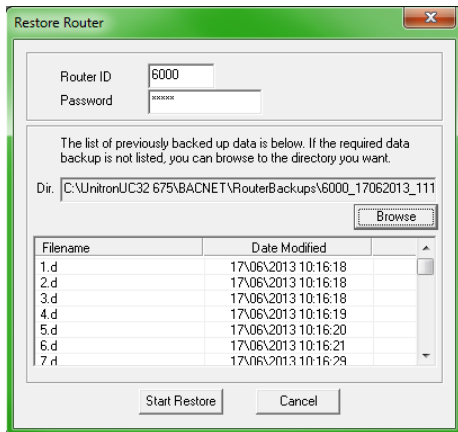

Click the **Start Restore** button.

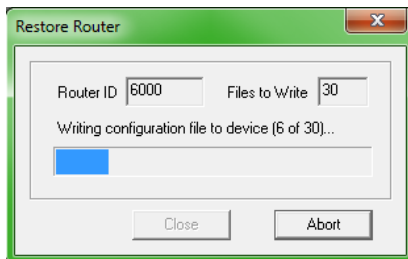

The restore process can be cancelled if required by clicking the **Abort** button.

When the process is complete, click the **Close** button.

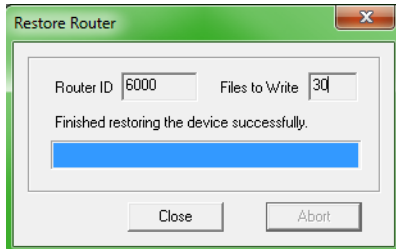

# 6 Appendices

## APPENDIX – BACNET PARAMETERS

| Parameter   | Limits                                   |
|---|--|
| Total number of Analog Values and Binary Values (mapping table index) | 225                                      |
| MSTP Station (MAC Address/BACnet ID/Token Passing ID)                 | 0-127                                    |
| Device Instance Number (Device ID)                                    | 0-4194303                                |
| MAX Masters   | 1-127                                    |
| APDU Timeout  | 10 - 60                                  |
| MSTP Baud rates   | 9600, 19200, 38400, 57600, 76800, 115200 |
| Device Name (Character support)                                       | 63 characters                            |
| Description String  | 63 characters                            |
| Location string   | 63 characters                            |
| Apps version string   | 63 characters                            |
| Point Names   | 63 characters                            |

### Notes:

Device Instance Number is the unique ID for the device in the BACnet system.  
MS/TP MAC address must be unique for all devices on a shared (single) MS/TP trunk.

## APPENDIX - UNDERSTANDING BACNET MS/TP

BACnet MS/TP (Master-Slave/Token-Passing) is a data-link protocol unique to BACnet. It uses EIA-485 signaling over a twisted-pair line and is the lowest cost LAN option in BACnet.

A BACnet MS/TP device is either a Master Node or a Slave Node. With Token-Passing, the entire MS/TP Fieldbus is controlled by a single Token that is passed around from Master Node to Master in order of MS/TP MAC address (Medium Access Control address range of 0–127). A Master Node that holds the Token can transmit a pre-defined number of information frames (`Max_Info_Frames`) before it has to pass the Token. The `Max_Info_Frames` is configurable and set to 20 in Cylon's BACnet router and 8 in Cylon's BACnet controllers. On receiving the Token a controller will transmit packets required for reading and writing BACnet data as well as packets required for any internal processing within the controller. Namely:

- BACnet requests and responses
- Reading / Writing of data

On a busy 32-controller network with a Baud Rate of 38400 it can take 1.24 seconds to pass the Token around the network.

After receiving the Token 50 times, a Master Node transmits a `Poll_For_Master` frame in order to discover the presence of other Master Nodes on the network that wish to join the ring. If one is found, it becomes the new successor node in the Token ring. If the successor is already the next available address then this step is omitted.

A Slave Node (MAC address range of 0 – 254) simply waits for a Master Node to query it using a “Data Expecting Reply” message, and it responds. It does not participate in the Token passing. A Slave Node can also receive “Data Not Expecting Reply” frames, such as a Broadcast Time Synchronization service, but cannot send any messages on its own.

All Cylon BACnet controllers are Master devices.

## COMMUNICATION ON AN MS/TP FIELDBUS

The performance of an MS/TP network is directly affected by the traffic load and configuration of the network. The following can affect network performance:

### Size of the Network

As the number of controllers on the network increases, the Token must be passed to more controllers and it is likely more information frames will be transmitted in total. As a result, the time for the Token to pass through the entire network will increase.

### Gaps in the Network

After 50 cycles of the Token, each Master Node will poll for the next Master on the network. If there is a gap in the MAC addresses on the network or if a controller is offline, it will take a minimum of 100 milliseconds for the Master Node before that gap to retry sending, during which time there will be no communications on the network. This will cause a slowdown in the passing of the Token through the network as the Master Node retries. Slowdown in the network will be significantly higher if the Max Master controller is the gap in the network.

## Network Load

The amount of activity on a network will affect performance. Examples of activity are:

- Who-is / I-Am request responses
- COV subscription
- Reading / Writing (for example reading a point, downloading a Strategy to a controller)
- Global Servicing
- Alarms Reporting

## Baud Rate

Increasing the Baud rate will allow data to transmit faster throughout the network thus increasing performance. Cylon supports Baud rates up to 76800.

## Max\_Masters

Max\_Masters on a BACnet Router specifies the highest MAC address of BACnet Routers on the Site. The default for **Cylon BACnet** Routers is 127.

Max\_Masters on a Field Controller specifies the highest MAC address of Master Nodes on the MS/TP network. This can be set to 127 for all devices except the last device on the network which should be set to MAC address of the device. If the Max\_Masters is set to an address higher than the last device on the network, a slowdown similar to that of a gap in the network will be experienced.

**For example, a network with 16 controllers, controllers 1 – 15 should have a Max\_Masters of 127, and controller 16 should have a Max\_Masters of 16.**

## Max\_Info\_Frames

Max\_Info\_Frames is set to 8 by default in the Cylon system. A setting of 8 will allow the node with the Token to initiate communication 8 times before it has to retire the Token to the next Master Node on the network segment.

**For example, if a controller needs to send a COV, a Global, and a BACnet Alarm, it would use 3 of its 8 info\_frames.**



## SCENARIOS

The time to read or write to or from a BACnet controller is:

No. of Packets \* (Token Cycle Time \* x)

Where x varies between 1.0 and 2.0 and is influenced by the MAC address of the controller in relation to the router MAC address.

As an example, strategies for a **CBM** and **CBT** containing 430 blocks and 255 blocks respectively (255 of which were BACnet enabled) were downloaded remotely to the following network sizes and types:

| # Controllers | Fieldbus Status | Strategy Download      | Firmware Upgrade |
|---------------|-----------------|------------------------|------------------|
|               |                 | Seconds Per Controller |                  |
| 3 * CBMs      | Wiped           | 29                     | 315              |
| 32 * CBMs     | Servicing       | 35                     | 420              |
| 32 * CBTs     | Servicing       | 29                     | 190              |
| 64 * CBTs     | Servicing       | 52                     | 195              |

- Running two instances of firmware upgrade to two separate controllers on the MS/TP Fieldbus slightly speeds up both downloads as the router holds on to the token for its Max\_Info\_Frames setting rather than for one packet on each receipt of the Token.
- A MAX\_INFO\_FRAMES of 100 is recommended for optimal performance

## Recommendations

To save time when downloading a complete Strategy, direct serial connection should be used if possible. For partial downloads, remote download can be used.

On trunks that might require continuous re-commissioning/downloading, limiting the number of controllers on each trunk would be prudent, while pre-loading each Strategy serially for bigger trunks will speed up engineering. Keeping main plant trunks to 16 controllers or less (as per **Unitron**) will help as a guideline.

Approaches for significantly improving download performance are currently under investigation.

## APPENDIX: QUICKSTART GUIDE

There are a number of different ways that MS/TP addresses can be assigned to **Cylon BACnet** Controllers. Depending on the circumstances, one method might be preferable over the others. This guide outlines 5 such methods, so that in whatever circumstance an address conflict arises, a suitable method for resolving it will be available.

### BACKGROUND

The BACnet MAC address (0-127) should be unique among all controllers that will share the EIA-485 MS/TP network. The Device Instance Number (0 - 4194302) must be unique among all Controllers on the BACnet Site.

**Cylon BACnet Routers** are configured during production to have a MAC address of 0.

Controllers built and shipped after the 7.6.5 firmware release (September 2015) are factory-configured with BACnet MAC address set to the last 2 digits of the serial number, unless that number would conflict with the default **CBR** – i.e. 00 – in which case they are assigned the address “100”.

The Device Instance Number of controllers built and shipped after the release of firmware version 7.6.5 (September 2015) is set to the entire numeric portion of the Controller's serial number.

All **Cylon BACnet** controllers built before the 7.6.5 firmware release shipped with the same MS/TP address and the same Device Instance Number.

With earlier models, where the MAC addresses were always identical, it was essential that the network addressing be changed before putting them on the network. With the serial number-based addressing it is no longer essential to manually set the address of every Controller, but there is still a possibility that some conflicts may be found when Controllers are first attached to an MS/TP network.

**Note:** Changing the address of the Controller will not affect any other programming on the controller. The Strategy (if one exists) will not be affected by these changes.

### METHOD 1: THE VT100 TERMINAL INTERFACE

The RS232 serial link (Service Port) can be used to communicate directly to the controller using any VT100 software tool. Popular free options include **Terra Term** and **Hyper Terminal** among others.

Connect the Cylon Controller's Service Port (RS232 serial link) to the computer. Open the VT100 application and connect to the serial port at 9600bps with all other settings at their defaults.

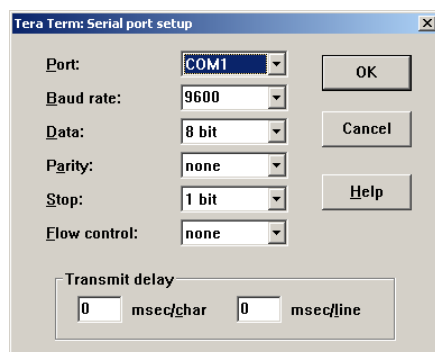

By typing “`Enter Terminal Mode`” into the interface, the **Cylon Terminal Menu** will appear on the screen:

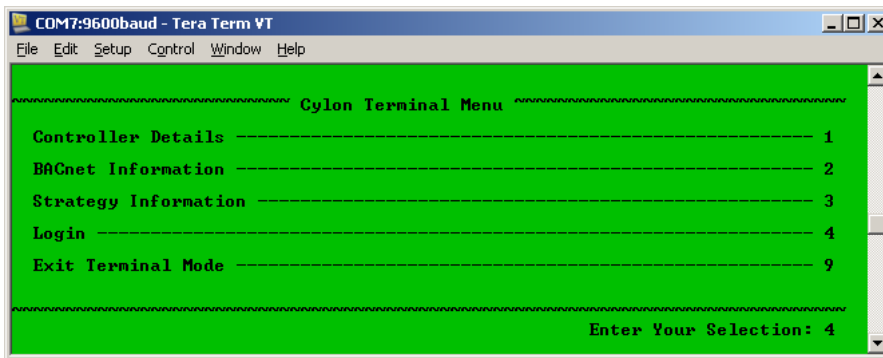

By default this screen allows data to be read but not modified.

To modify the BACnet data:

1. Press **4** to open the **Login** page
2. entering the password “Cylon”

This will bring up the **Level 1 Access Menu**, with Write privileges:

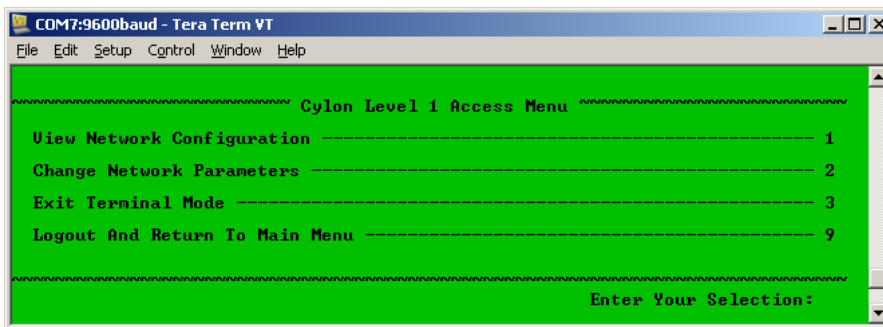

Press “**2**” to open the **Change Network Parameters** menu to view and modify the following parameters:

- Device Instance
- MS/TP (MAC) Address
- Unitron ID
- Max Master
- Baud Rate
- Device Name

Once the configuration is complete the interface can be disconnected. All changes are stored to flash in real time and no delay is needed before cycling power.

## METHOD 2: NETLINK

**NetLink** is a Cylon tool that is used to commission Controllers over the serial port. It has the ability to clone devices, modify points and also change the network parameters.

Connect power to the controller.

**Note:** Service Port (serial connection) must not be connected until after the device is powered on.

Connect the Cylon Controller's Service Port (RS232 serial link) to the computer.

Launch **NetLink** and specify the serial port number.

Click on **NetLink's** **Controller Setup** tab to open the **BACnet Controller Setup** dialog showing live data:

| Field                  | Value  |
|------------------------|--------|
| Site Number            | 1      |
| Comms Controller       | 1      |
| Field Controller       | 25     |
| MSTP Baud Rate         | 38400  |
| Device ID              | 999803 |
| Device Name            | New FW |
| APDU Timeout (seconds) | 10     |
| MSTP Station           | 20     |
| MSTP Max Masters       | 127    |

Any changes made within this dialog will be sent down to the controller as soon as the **OK** button is pressed.

## METHOD 3: CYLON ENGINEERING CENTER

The BACnet configuration parameters can be accessed and modified by the **Cylon Engineering Center** when it is connected via the Service Port (RS232 serial link). For detailed instructions see

*How to configure Cylon BACnet Field Controllers on page 59.*

## METHOD 4: VIA BACNET MS/TP

All of the BACnet points on a Cylon Controller can be exposed to IP-based BACnet tools such as **NB-Pro** by temporarily attaching the Controller to a router.

This allows the Controller's BACnet parameters to be configured by scanning for the controller and then writing directly to the BACnet parameters using the IP-based tools.

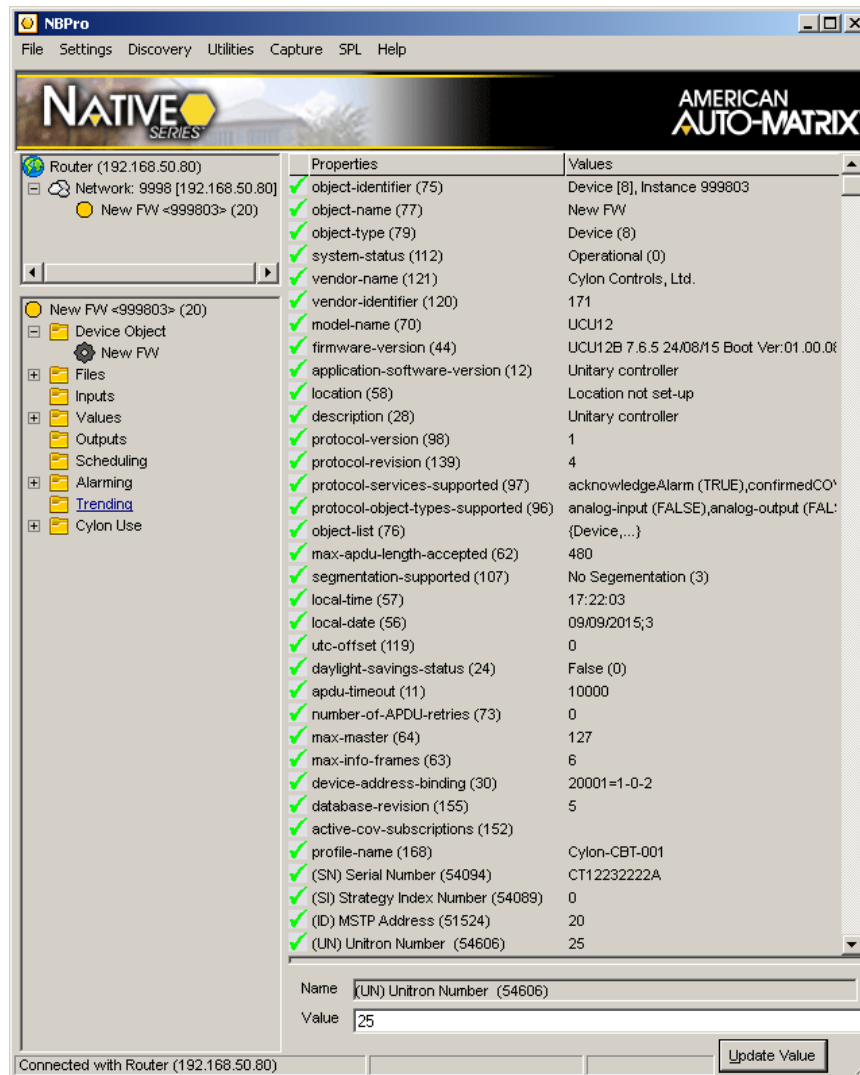

A view of the Device Object over BACnet in **NB-Pro**

From the Device object one can directly modify the following network parameters:

- Device Instance
- Device Name
- Description
- Max Master
- Max Info Frames
- MS/TP (MAC) Address
- Unitron ID1

## METHOD 5: CBT-STAT (CBT12IVAV ONLY)



If there is a **CBT-STAT** attached to the controller it may also be used to change the BACnet parameters.

Engineering Mode on the **CBT-STAT** has the ability to change many parameters on the **CBT12iVAV**. These parameters are organized by Line, and collections of Lines are organized into pages. Page 1, the Device Setup page contains the following three lines: Device Instance, MS/TP (MAC) Address and Baud Rate.

How to use the **CBT-STAT**'s Engineering Mode is briefly outlined below. Please refer to *MAN0120US CBT-STAT and CBT-STAT-H for CBT12iVAV* for more details.

To enter Engineering Mode:

- Press and hold (“long-press”) both the Up button ▲ and Down button ▼ together for at least 3 seconds until the 1st line **a** (large digits) displays the text 5555 and the 2nd line **b** displays with the right-most digit flashing.
- Enter the Engineering Mode password by changing the number on the 2nd line **b** as follows:
- Press the up ▲ button or down ▼ button to change the value of the flashing digit.
- Use the left ◀ and right ▶ buttons to move between digits.

The password can be changed via the smart-stat block in the **CBT12iVAV** Strategy, but by default it is set to 9999.

Once the correct password is displayed on the screen, press and hold the right ▶ button to enter it.

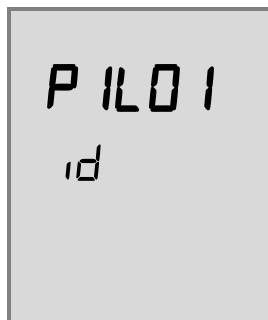

When the correct password is entered, the Engineering Menu page 1 line 01 - the Device Instance Number - will be displayed. This is indicated in the display as follows:



From inside this Engineering Menu the up and down arrows will toggle between the Lines and the right and left arrows will toggle between the Pages.

**CBT-STAT** Menu Page 1: Device Setup

| Line | Display     | Parameter       | Range  |
|------|-------------|-----------------|--|
| 01   | P 1L01 id   | Device Instance | 0-4 194303   |
| 02   | P 1L02 nAC  | MSTP Station    | 0 127  |
| 03   | P 1L03 bAUd | Baud Rate       | 0 = 9,600 baud,<br>1 = 19,200 baud<br>2 = 38,400 baud<br>3 = 76,800 baud |

Press and hold the right  button to view or edit a line. Once the parameter has been changed to the desired setting, press and hold the right  button to enter it and return to the page view.



## APPENDIX – TROUBLESHOOTING

If the **Cylon Engineering Center** software cannot communicate with a BACnet Field Controller, check the following:

- Make sure the PC's Operating System is Windows 7 Professional 32/64bit.
- Make sure that no other BACnet software is running on the PC.
- Check that the file `C:\UnitronUC32\Bacdoc.ini` has the current IP address of the PC (this is set in the **Cylon Configuration Utility (CCConfig)** – see

- *How to configure Cylon BACnet Field Controllers / Step 1: Choose a Network Adapter for BACnet comms on page 59).*
- Check that the file `C:\UnitronUC32\Bacdoc.ini` has the correct list of BACnet devices on the network.
- Check that the green light on the Field Controller is flashing (if not, then the Router is not communicating with the Field Controller).

## **APPENDIX: MAXIMIZING STRATEGY DOWNLOAD PERFORMANCE**

Downloading Strategies to a large number of controllers can take a considerable time, due to the factors described in

*Appendix - Understanding BACnet MS/TP on page 103.*

However there are a number of approaches that can be take that will minimize the amount of time required to, for example, upgrade all of the Strategies or Firmware on a Site.

### **UPDATE IN PARALLEL**

This approach simply uses a separate instance of the **Site Organizer** for each trunk (Fieldbus). If you have enough **Engineering Center** licenses, connect a separate PC/Laptop to each Comms Controller and send the required Strategies to the controllers on all trunks at the same time.

### **WIPE ALL OF THE CONTROLLERS**

If the building is currently unoccupied, wiping all of the controllers before starting Strategy download will significantly reduce the time taken to complete the download. This is because of the absence of network traffic originating from the controllers during download, which would slow all traffic as described in described in

### *Appendix - Understanding BACnet MS/TP .*

In this situation, the building would be uncontrolled for the duration of the Site upgrade.

### **QUIETEN CONTROLLERS USING DCC**

The BACnet protocol allows controllers to be commanded to be 'quiet' – i.e. not to initiate communication. This has the same effect as the scenario described in *Wipe all of the Controllers* above, but in this case the Controllers continue to control the building environment.

This approach would be best if the building is occupied, but it requires a 3<sup>rd</sup>-party tool to generate the BACnet DCC command.

## APPENDIX: ENGINEERING DATA EXCHANGE (EDE)

### OVERVIEW

The Engineering Data Exchange (EDE) helps to exchange engineering data, such as data point types, data point addresses and special data point presentation information in a standardized form.

The EDE files can be used to import data into a BACnet Operator Workstation (BOWS).

In order to use EDE, the full Site must be exported (see *Full EDE export* below). It is possible to subsequently update the EDE files for part of the Site (see *Partial EDE Export* on page 120), but only after an initial full export.

### FULL EDE EXPORT

The Cylon EDE process is initiated using Site Navigation in the Engineering Tool.

Right-click on the Site root and choose **Create BACnet EDE Data**:

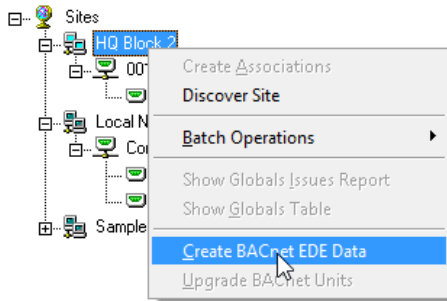

A warning dialog box is displayed regarding the backup of the Site before EDE creation:

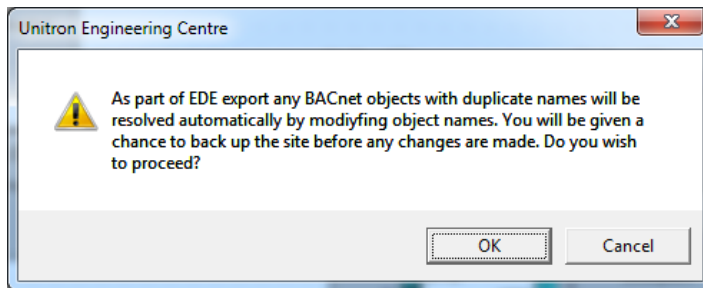

Click **OK** to proceed.

An option to back up the Site before EDE export is offered. It is recommended that this is done, because the export procedure may change object names if duplicates exist

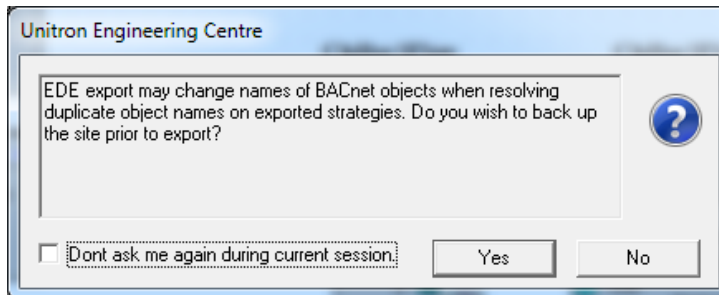

To create a backup (recommended) click **Yes**

The **Site Backup utility** will be launched. Select the Site,

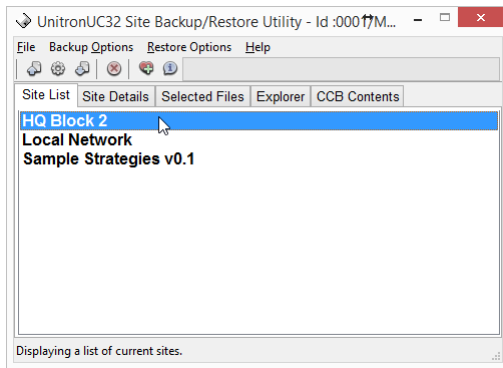

And start the backup

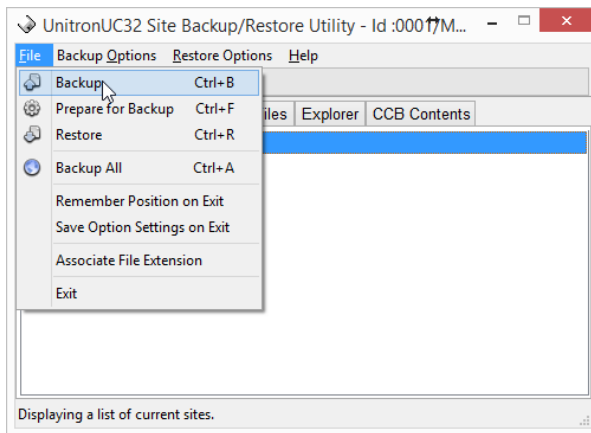

When the **Site Backup utility** has finished and closed, the EDE process will continue:

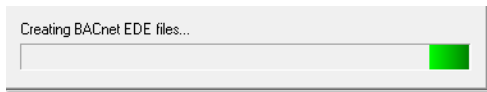

Assuming that the **Cylon Engineering Center** is installed on the **C** drive and in the **UnitronUC32** folder, four **.csv** files will be created in the folder

C:\UnitronUC32\Site Folder\BACnetEDE

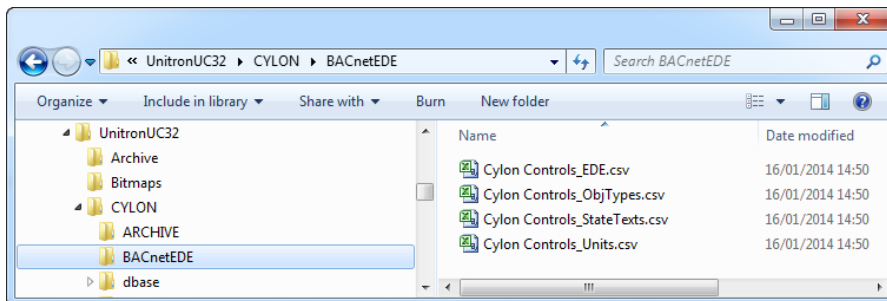

## PARTIAL EDE EXPORT

Once an EDE export exists, and the folder `C:\UnitronUC32\Site Folder\BACnetEDE` has been created, it is possible to update parts of the Site without carrying out a complete EDE export.

To do this, click on a router that contains the part of the Site to be exported, and select **Update BACnet EDE Data**:

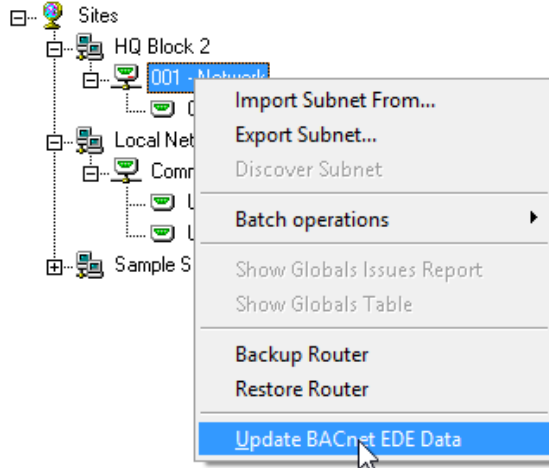

A warning dialog box is displayed regarding the backup of the Site before EDE creation:

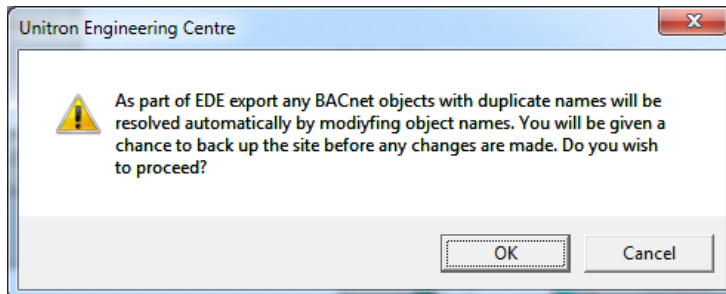

Click **OK** to proceed.

An option to back up the Site before EDE export is offered. It is recommended that this is done, because the export procedure may change object names if duplicates exist

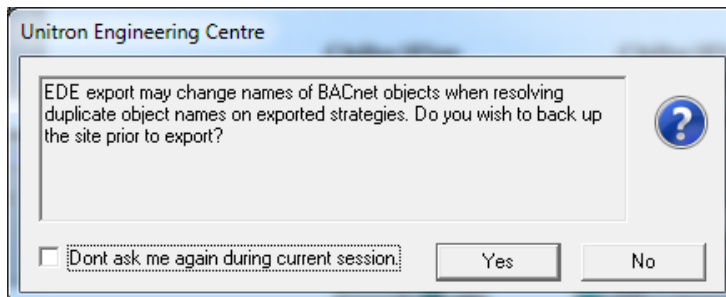

To create a backup (recommended) click **Yes**



The **Site Backup utility** will be launched. Select the Site,

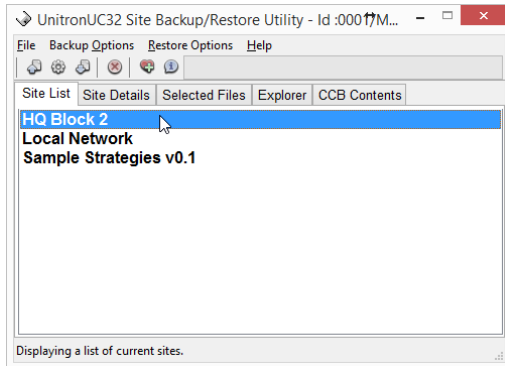

and start the backup

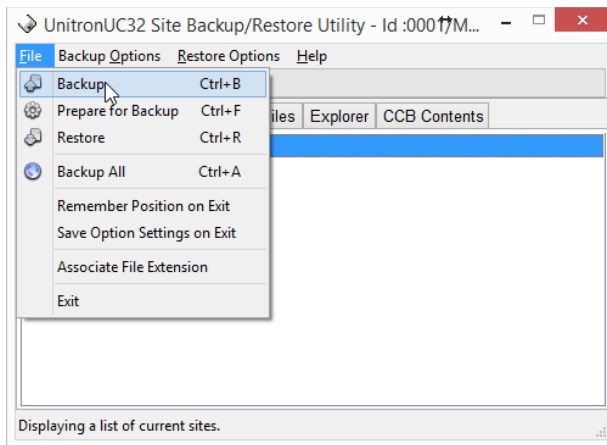

When the **Site Backup utility** has finished and closed, the EDE process will continue:

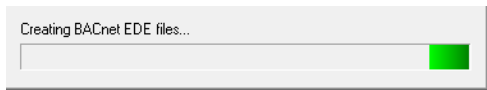

The files created in the initial full EDE export (see *Full EDE export* on page 118) will be updated.

## APPENDIX : USING AN OPTIMIZER MACRO WITH BACNET

When using the Optimizer macro, a Time Schedule must be set up external to the macro, along with any other required Strategy logic.

In a BACnet Site, an additional BACnet Schedule block is required.

It must be added immediately before the 7 weekday schedules – i.e. it must be the last block added to the strategy before the Optimizer blocks (or Optimizer macro) are added, so that the block numbers of the blocks in the Optimizer directly follow the block number of the BACnet Schedule (This is because of assumptions built into the way the external BACnet Schedule writes to the schedule blocks inside the Optimizer).

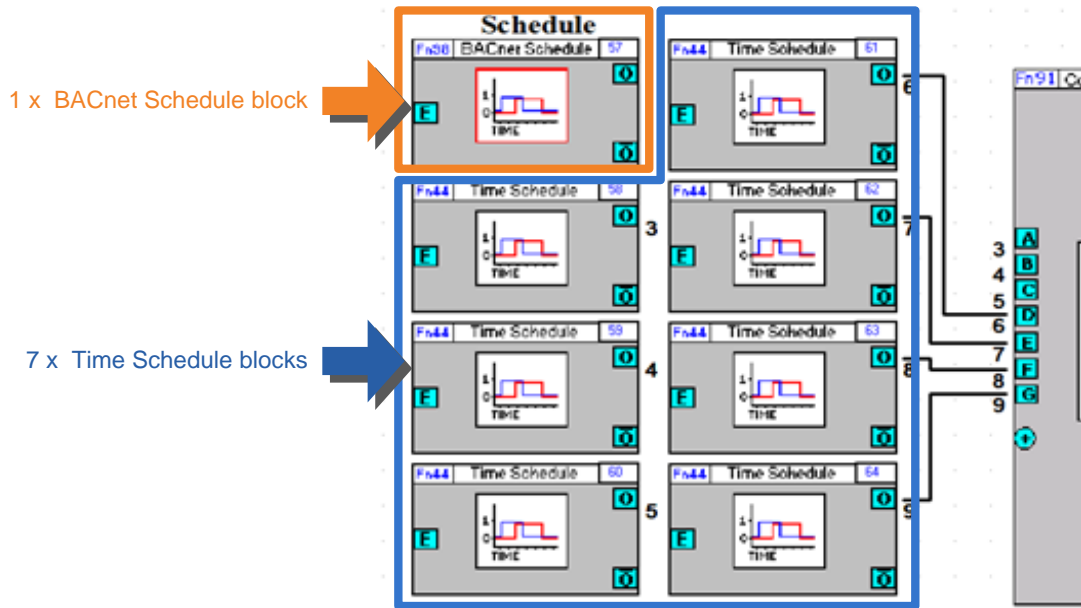

Each of the day values in this BACnet Time Schedule will be automatically copied to the relevant Time Schedule block.

## APPENDIX: PROTOCOL IMPLEMENTATION CONFORMANCE STATEMENT (PICS)

### CBR (UC32.NET BACNET IP-TO-MSTP ROUTER)

|                                      |  |
|--------------------------------------|--|
| <b>Date</b>                          | September 2014                             |
| <b>Vendor Name</b>                   | Cylon Controls Ltd.                        |
| <b>Product Name:</b>                 | ABB Cylon® BACnet®                         |
| <b>Product Model Number:</b>         | ABB Cylon® BACnet®                         |
| <b>Application Software Version:</b> | Router MP1, Router MP2, ModM MP1, ModM MP2 |
| <b>Firmware Revision:</b>            | 3.06.02                                    |
| <b>BACnet Protocol Revision:</b>     | 1.7  |

#### Product Description

- The BACnet Communication Controllers are high-performance BACnet/IP to BACnet MS/TP Routers.
- An optional Modbus to BACnet gateway is also available, which allows Modbus RTU devices to be mapped and registered to BACnet devices and point Objects.
- The device is designated for DIN-rail mounting and 24 hour per day operation.
- Both 10Mbits/s and 100Mbit/s Ethernet network connections are supported.
- Standard BACnet MS/TP baud rates up to 76800 are supported.
- Additionally BBMD and FD modes are supported.
- The configuration is done via standard web browser.

#### BACnet Standardised Device Profile (Annex L)

- BACnet Operator Workstation (**B-AWS**)
- BACnet Operator Workstation (**B-OWS**)
- BACnet Building Controller (**B-BC**)
- BACnet Advanced Application Controller (**B-AAC**)
- BACnet Application Specific Controller (B-ASC)**
- BACnet Smart Sensor (**B-SS**)
- BACnet Smart Actuator (**B-SA**)
- BACnet Other (**B-OTHER**)

BACnet Interoperability Building Blocks Supported (Annex K)

| ID     | BIBB     | Application Service                                |
|--------|----------|--|
| K.1.2  | DS-RP-B  | Data Sharing – ReadProperty-B                      |
| K.1.4  | DS-RPM-B | Data Sharing – ReadPropertyMultiple-B              |
| K.1.8  | DS-WP-B  | Data Sharing – WriteProperty-B                     |
| K.1.10 | DS-WPM-B | Data Sharing – WritePropertyMultiple-B             |
| K.5.2  | DM-DDB-B | Device Management – Dynamic Device Binding-B       |
| K.5.4  | DM-DOB-B | Device Management – Dynamic Object Binding-B       |
| K.5.6  | DM-DCC-B | Device Management – Device Communication Control-A |
| K.5.11 | DM-TS-A  | Device Management – TimeSynchronization-B          |
| K.5.12 | DM-TS-B  | Device Management – TimeSynchronization-B          |
| K.5.18 | DM-BR-B  | Device Management – Backup and Restore-B           |

Segmentation Capability

- Able to transmit segmented messages      Window Size: N/A
- Able to receive segmented messages      Window Size: N/A

## Standard Object Types Supported:

- access-door
- accumulator
- analog-input (Virtual Modbus Device only)**
- analog-output
- analog-value**
- averaging
- binary-input (Virtual Modbus Device only)**
- binary-output
- binary-value**
- calendar
- command
- device**
- event-enrollment
- event-log
- file
- group
- life-safety-point
- life-safety-zone
- load-control
- loop
- multi-state-input
- multi-state-output
- multi-state-value
- notification-class
- program
- pulse-converter
- schedule
- structured-view
- trend-log
- trend-log-multiple

**For all of these objects the following apply:**

1. The CreateObject and DeleteObject services are not supported, so no objects are dynamically creatable or deletable through BACnet service requests, Virtual Modbus Objects are dynamically creatable and deletable through the CBR configuration web pages.
2. Client functionality is used by the CBR to send time sync and who-is (when viewing MS/TP port information via configuration web pages).
3. No general range restrictions exist.
4. Not all instances support optional properties (see tables below).

For each of these objects, the supported properties are listed below:

analog-input (Virtual Modbus Device only)

- Dynamically Creatable       Dynamically Deletable

| Property          | Read                                | Write                    | optional |
|-------------------|-------------------------------------|--------------------------|----------|
| object-identifier | <input checked="" type="checkbox"/> |                          |          |
| object-name       | <input type="checkbox"/>            |                          |          |
| object-type       | <input type="checkbox"/>            |                          |          |
| present-value     | <input type="checkbox"/>            | <input type="checkbox"/> |          |
| status-flags      | <input type="checkbox"/>            |                          |          |
| event-state       | <input type="checkbox"/>            |                          |          |
| out-of-service    | <input type="checkbox"/>            |                          |          |
| units             | <input type="checkbox"/>            |                          |          |

analog-value

- Dynamically Creatable       Dynamically Deletable

| Property          | Read                     | Write                    | optional |
|-------------------|--------------------------|--------------------------|----------|
| object-identifier | <input type="checkbox"/> |                          |          |
| object-name       | <input type="checkbox"/> |                          |          |
| object-type       | <input type="checkbox"/> |                          |          |
| present-value     | <input type="checkbox"/> | <input type="checkbox"/> |          |
| status-flags      | <input type="checkbox"/> |                          |          |
| event-state       | <input type="checkbox"/> |                          |          |
| out-of-service    | <input type="checkbox"/> |                          |          |
| units             | <input type="checkbox"/> |                          |          |

binary-input (Virtual Modbus Device only)

- Dynamically Creatable       Dynamically Deletable

| Property          | Read                     | Write                    | optional |
|-------------------|--------------------------|--------------------------|----------|
| object-identifier | <input type="checkbox"/> |                          |          |
| object-name       | <input type="checkbox"/> |                          |          |
| object-type       | <input type="checkbox"/> |                          |          |
| present-value     | <input type="checkbox"/> | <input type="checkbox"/> |          |
| status-flags      | <input type="checkbox"/> |                          |          |
| event-state       | <input type="checkbox"/> |                          |          |

| Property                          | Read                     | Write | optional                 |
|-----------------------------------|--------------------------|-------|--------------------------|
| out-of-service                    | <input type="checkbox"/> |       |                          |
| Polarity ( <b>Note:</b> Only BIs) | <input type="checkbox"/> |       |                          |
| inactive-text                     | <input type="checkbox"/> |       | <input type="checkbox"/> |
| active-text                       | <input type="checkbox"/> |       | <input type="checkbox"/> |

binary-value

Dynamically Creatable

Dynamically Deletable

| Property          | Read                     | Write                    | optional                 |
|-------------------|--------------------------|--------------------------|--------------------------|
| object-identifier | <input type="checkbox"/> |                          |                          |
| object-name       | <input type="checkbox"/> |                          |                          |
| object-type       | <input type="checkbox"/> |                          |                          |
| present-value     | <input type="checkbox"/> | <input type="checkbox"/> |                          |
| status-flags      | <input type="checkbox"/> |                          |                          |
| event-state       | <input type="checkbox"/> |                          |                          |
| out-of-service    | <input type="checkbox"/> |                          |                          |
| inactive-text     | <input type="checkbox"/> |                          | <input type="checkbox"/> |
| active-text       | <input type="checkbox"/> |                          | <input type="checkbox"/> |

device

Dynamically Creatable

Dynamically Deletable

| Property                        | Read                                | Write                               | optional                 | Values          |
|---------------------------------|-------------------------------------|-------------------------------------|--------------------------|-----------------|
| object-identifier               | <input checked="" type="checkbox"/> | <input checked="" type="checkbox"/> |                          | (ID, 0-4194302) |
| object-name                     | <input type="checkbox"/>            | <input type="checkbox"/>            |                          | (max 63 chars)  |
| object-type                     | <input type="checkbox"/>            |                                     |                          |                 |
| system-status                   | <input type="checkbox"/>            |                                     |                          |                 |
| vendor-name                     | <input type="checkbox"/>            |                                     |                          |                 |
| vendor-identifier               | <input type="checkbox"/>            |                                     |                          |                 |
| model-name                      | <input type="checkbox"/>            |                                     |                          |                 |
| firmware-revision               | <input type="checkbox"/>            |                                     |                          |                 |
| application-software-version    | <input type="checkbox"/>            |                                     |                          |                 |
| protocol-version                | <input type="checkbox"/>            |                                     |                          |                 |
| protocol-revision               | <input type="checkbox"/>            |                                     |                          |                 |
| protocol-services-supported     | <input type="checkbox"/>            |                                     |                          |                 |
| protocol-object-types-supported | <input type="checkbox"/>            |                                     |                          |                 |
| object-list                     | <input type="checkbox"/>            |                                     |                          |                 |
| max-apdu-length-accepted        | <input type="checkbox"/>            |                                     |                          |                 |
| segmentation-supported          | <input type="checkbox"/>            |                                     |                          |                 |
| local-time                      | <input type="checkbox"/>            |                                     | <input type="checkbox"/> |                 |
| local-date                      | <input type="checkbox"/>            |                                     | <input type="checkbox"/> |                 |
| utc-offset                      | <input type="checkbox"/>            |                                     | <input type="checkbox"/> |                 |
| daylight-savings-status         | <input type="checkbox"/>            |                                     | <input type="checkbox"/> |                 |
| apdu-timeout                    | <input type="checkbox"/>            |                                     | <input type="checkbox"/> |                 |
| number-of-apdu-retries          | <input type="checkbox"/>            |                                     |                          |                 |
| max-master                      | <input type="checkbox"/>            | <input type="checkbox"/>            | <input type="checkbox"/> | (1-127)         |
| max-info-frames                 | <input type="checkbox"/>            | <input type="checkbox"/>            | <input type="checkbox"/> | (1-100)         |
| description                     | <input type="checkbox"/>            | <input type="checkbox"/>            | <input type="checkbox"/> | (max 63 chars)  |
| location                        | <input type="checkbox"/>            | <input type="checkbox"/>            | <input type="checkbox"/> | (max 63 chars)  |
| device-address-binding          | <input type="checkbox"/>            |                                     |                          |                 |



| Property                 | Read                     | Write | optional                 | Values |
|--------------------------|--------------------------|-------|--------------------------|--------|
| database-revision        | <input type="checkbox"/> |       |                          |        |
| active-cov-subscriptions | <input type="checkbox"/> |       | <input type="checkbox"/> |        |
| profile-name             | <input type="checkbox"/> |       | <input type="checkbox"/> |        |

**Property support summary**

| Property                 | Object Type                         |                                     |                                     |                                     |
|--------------------------|-------------------------------------|-------------------------------------|-------------------------------------|-------------------------------------|
|                          | Analog Input                        | Analog Value                        | Binary Input                        | Binary Value                        |
| Object_Identifier        | <input checked="" type="checkbox"/> | <input checked="" type="checkbox"/> | <input checked="" type="checkbox"/> | <input checked="" type="checkbox"/> |
| Object_Type              | <input checked="" type="checkbox"/> | <input checked="" type="checkbox"/> | <input checked="" type="checkbox"/> | <input checked="" type="checkbox"/> |
| Object_Name              | <input checked="" type="checkbox"/> | <input checked="" type="checkbox"/> | <input checked="" type="checkbox"/> | <input checked="" type="checkbox"/> |
| Present_Value            | <input checked="" type="checkbox"/> | <input checked="" type="checkbox"/> | <input checked="" type="checkbox"/> | <input checked="" type="checkbox"/> |
| Status_Flags             | <input checked="" type="checkbox"/> | <input checked="" type="checkbox"/> | <input checked="" type="checkbox"/> | <input checked="" type="checkbox"/> |
| Event_State              | <input checked="" type="checkbox"/> | <input checked="" type="checkbox"/> | <input checked="" type="checkbox"/> | <input checked="" type="checkbox"/> |
| Out_Of_Service           | <input checked="" type="checkbox"/> | <input checked="" type="checkbox"/> | <input checked="" type="checkbox"/> | <input checked="" type="checkbox"/> |
| Units                    | <input checked="" type="checkbox"/> | <input checked="" type="checkbox"/> |                                     |                                     |
| Polarity                 |                                     |                                     | <input checked="" type="checkbox"/> |                                     |
| Inactive_Text (optional) |                                     |                                     | <input checked="" type="checkbox"/> | <input checked="" type="checkbox"/> |
| Active_Text (optional)   |                                     |                                     | <input checked="" type="checkbox"/> | <input checked="" type="checkbox"/> |

**Data Link Layer Options:**

- BACnet IP, (Annex J)**
- BACnet IP, (Annex J), Foreign Device**
- ISO 8802-3, Ethernet (Clause 7)
- ATA 878.1, 2.5 Mb. ARCNET (Clause 8)
- ATA 878.1, EIA-485 ARCNET (Clause 8), baud rate(s) : N/A
- MS/TP master (Clause 9)**, baud rate(s): **9600, 19200, 38400, 76800**
- MS/TP slave (Clause 9), baud rate(s): N/A
- Point-To-Point, EIA 232 (Clause 10), baud rate(s): N/A
- Point-To-Point, modem, (Clause 10), baud rate(s): N/A
- LonTalk, (Clause 11), medium: N/A
- Other: N/A

**Device Address Binding:**

Is static device binding supported?  **Yes**  No

(This is currently necessary for two-way communication with MS/TP slaves and certain other devices.)

**Networking Options:**

- Router, Clause 6 - IP, MS/TP, Ethernet**
- Annex H, BACnet Tunneling Router over IP
- BACnet/IP Broadcast Management Device (BBMD)**
- Does the BBMD support registrations by Foreign Devices?  **Yes**  No

Character Sets Supported:

Indicating support for multiple character sets does not imply that they can all be supported simultaneously.

- |  |   |                                     |
|--|---|-------------------------------------|
| <input checked="" type="checkbox"/> ANSI X3.4. | <input type="checkbox"/> IBM™/Microsoft™ DBCS | <input type="checkbox"/> ISO 8859-1 |
| <input type="checkbox"/> ISO 10646 (UCS-2)     | <input type="checkbox"/> ISO 10646 (UCS-4)    | <input type="checkbox"/> JIS C 6226 |

If this product is a communication gateway, describe the types of non-BACnet equipment/networks(s) that the gateway supports:

N/A

**CBM AND CBX MAIN PLANT CONTROLLERS AND CBT UNITARY CONTROLLER**

|                                  |   |
|----------------------------------|---|
| <b>Date</b>                      | June 2017   |
| <b>Vendor Name</b>               | Cylon Controls  |
| <b>Product Name:</b>             | ABB Cylon® BACnet   |
| <b>Product Model Number:</b>     | CBX-8R8, CBM08, CBM12, CBM16, CBM24, CBM24K, CBM24LC, CBT12, CBT12iVAV, CBT14 |
| <b>Firmware Revision:</b>        | 7.8.0 or later  |
| <b>BACnet Protocol Revision:</b> | 14  |

**Product Description**

The CBM/CBT BACnet Field controller is part of the Cylon BACnet system. The Controller can operate stand-alone or can be networked to perform complex Plant (CBM) / Unitary (CBT) HVAC control, monitoring and energy management functions via BACnet MS/TP.

**BACnet Standardised Device Profile (Annex L)**

- BACnet Operator Workstation (**B-AWS**)
- BACnet Operator Workstation (**B-OWS**)
- BACnet Building Controller (**B-BC**)
- BACnet Advanced Application Controller (B-AAC)**
- BACnet Application Specific Controller (**B-ASC**)
- BACnet Smart Sensor (**B-SS**)
- BACnet Smart Actuator (**B-SA**)
- BACnet Other (**B-OTHER**)

BACnet Interoperability Building Blocks Supported (Annex K)

| ID     | BIBB      | Application Service                                |
|--------|-----------|--|
| K.1.1  | DS-RP-A   | Data Sharing – ReadProperty-A                      |
| K.1.2  | DS-RP-B   | Data Sharing – ReadProperty-B                      |
| K.1.4  | DS-RPM-B  | Data Sharing – ReadPropertyMultiple-B              |
| K.1.7  | DS-WP-A   | Data Sharing – WriteProperty-A                     |
| K.1.8  | DS-WP-B   | Data Sharing – WriteProperty-B                     |
| K.1.10 | DS-WPM-B  | Data Sharing – WritePropertyMultiple-B             |
| K.1.12 | DS-COV-B  | Data Sharing – COV-B                               |
| K.2.2  | AE-N-I-B  | Alarm & Event – Notification Internal-B            |
| K.2.5  | AE-ACK-B  | Alarm & Event – Ack-B                              |
| K.2.7  | AE-ASUM-B | Alarm & Event – Alarm Summary-B                    |
| K.2.11 | AE-INFO-B | Alarm & Event – Information-B                      |
| K.3.2  | SCHEM-I-B | Scheduling – Internal-B                            |
| K.4.2  | T-VMT-I-B | Trending – Viewing and Modifying Trends Internal-B |
| K.4.5  | T-ATR-B   | Trending – Automated Trend Retrieval-B             |
| K.5.1  | DM-DDB-A  | Device Management – Dynamic Device Binding-A       |
| K.5.2  | DM-DDB-B  | Device Management – Dynamic Device Binding-B       |
| K.5.4  | DM-DOB-B  | Device Management – Dynamic Object Binding-B       |
| K.5.6  | DM-DCC-B  | Device Management – Device Communication Control-B |
| K.5.12 | DM-TS-B   | Device Management – TimeSynchronization-B          |
| K.5.14 | DM-UTC-B  | Device Management – UTCTimeSynchronization-B       |
| K.5.16 | DM-RD-B   | Device Management – ReinitializeDevice-B           |

Segmentation Capability

- Able to transmit segmented messages      Window Size: N/A
- Able to receive segmented messages      Window Size: N/A

## Standard Services Supported

| Service           | Property  |
|-------------------|---|
| Object access     | Write property  |
| Object access     | Read property   |
| Object access     | Read property multiple  |
| Object access     | Write property multiple   |
| Object access     | Read range<br><b>Note:</b> Used for reading TL and COV subscriptions          |
| Remote management | Who-is  |
| Remote management | I-am  |
| Remote management | Who-has   |
| Remote management | I-have  |
| Remote management | Unconfirmed private transfer<br><b>Note:</b> used by Cylon Engineering Center |
| Remote management | Time synchronization  |
| Remote management | UTC time synchronization  |
| Remote management | Device communication control  |
| Remote management | Reinitialize device   |
| File access       | Atomic write file   |
| File access       | Atomic read file  |
| Alarm/Event       | Acknowledge alarm   |
| Alarm/Event       | Get alarm summary   |
| Alarm/Event       | Get event information   |
| Alarm/Event       | Confirmed event notification  |
| Alarm/Event       | Unconfirmed event notification  |
| Alarm/Event       | Subscribe COV   |
| Alarm/Event       | Confirmed COV notification  |
| Alarm/Event       | Unconfirmed COV notification  |

## Standard Object Types Supported

- access-door
- accumulator
- analog-input**
- analog-output**
- analog-value**
- averaging
- binary-input**
- binary-output**
- binary-value**
- calendar**
- command
- device**
- event-enrollment
- event-log
- file**
- group
- life-safety-point
- life-safety-zone
- load-control
- loop
- multi-state-input
- multi-state-output
- multi-state-value
- notification-class**
- program
- pulse-converter
- schedule**
- structured-view
- trend-log**
- trend-log-multiple

**For all of these objects the following apply:**

1. The CreateObject and DeleteObject services are not supported, so no objects are dynamically creatable or deletable through BACnet service requests, although these objects are dynamically creatable and deletable through Cylon Control's Engineering Center Software.
2. Client functionality is used by the controller for reading and writing point objects present values between this controller and other BACnet controllers on the network. These transfers are set-up at engineering time using the Cylon Engineering Center.
3. No general range restrictions exist.
4. Not all instances support optional properties (see tables below).

For each of these objects, the supported properties are listed below:

analog-input

Dynamically Creatable

Dynamically Deletable

| Property           | Read                                | Write                    | optional                 |
|--------------------|-------------------------------------|--------------------------|--------------------------|
| object-identifier  | <input checked="" type="checkbox"/> |                          |                          |
| object-name        | <input type="checkbox"/>            | <input type="checkbox"/> |                          |
| object-type        | <input type="checkbox"/>            |                          |                          |
| present-value      | <input type="checkbox"/>            | <input type="checkbox"/> |                          |
| property-list      | <input type="checkbox"/>            |                          |                          |
| status-flags       | <input type="checkbox"/>            |                          |                          |
| event-state        | <input type="checkbox"/>            |                          |                          |
| reliability        | <input type="checkbox"/>            | <input type="checkbox"/> | <input type="checkbox"/> |
| out-of-service     | <input type="checkbox"/>            | <input type="checkbox"/> |                          |
| units              | <input type="checkbox"/>            |                          |                          |
| min-pres-value     | <input type="checkbox"/>            | <input type="checkbox"/> | <input type="checkbox"/> |
| max-pres-value     | <input type="checkbox"/>            | <input type="checkbox"/> | <input type="checkbox"/> |
| cov-increment      | <input type="checkbox"/>            | <input type="checkbox"/> | <input type="checkbox"/> |
| time-delay         | <input type="checkbox"/>            | <input type="checkbox"/> |                          |
| notification-class | <input type="checkbox"/>            | <input type="checkbox"/> |                          |
| high-limit         | <input type="checkbox"/>            | <input type="checkbox"/> |                          |
| low-limit          | <input type="checkbox"/>            | <input type="checkbox"/> |                          |
| deadband           | <input type="checkbox"/>            | <input type="checkbox"/> |                          |
| limit-enable       | <input type="checkbox"/>            | <input type="checkbox"/> |                          |
| event-enable       | <input type="checkbox"/>            | <input type="checkbox"/> |                          |
| acked-transitions  | <input type="checkbox"/>            |                          |                          |
| notify-type        | <input type="checkbox"/>            | <input type="checkbox"/> |                          |
| event-time-stamps  | <input type="checkbox"/>            |                          |                          |
| profile-name       | <input type="checkbox"/>            |                          | <input type="checkbox"/> |

analog-output

Dynamically Creatable

Dynamically Deletable

| Property           | Read                     | Write                    | optional                 |
|--------------------|--------------------------|--------------------------|--------------------------|
| object-identifier  | <input type="checkbox"/> |                          |                          |
| object-name        | <input type="checkbox"/> | <input type="checkbox"/> |                          |
| object-type        | <input type="checkbox"/> |                          |                          |
| present-value      | <input type="checkbox"/> | <input type="checkbox"/> |                          |
| property-list      | <input type="checkbox"/> |                          |                          |
| status-flags       | <input type="checkbox"/> |                          |                          |
| event-state        | <input type="checkbox"/> |                          |                          |
| reliability        | <input type="checkbox"/> | <input type="checkbox"/> | <input type="checkbox"/> |
| out-of-service     | <input type="checkbox"/> | <input type="checkbox"/> |                          |
| units              | <input type="checkbox"/> |                          |                          |
| min-pres-value     | <input type="checkbox"/> | <input type="checkbox"/> | <input type="checkbox"/> |
| max-pres-value     | <input type="checkbox"/> | <input type="checkbox"/> | <input type="checkbox"/> |
| resolution         | <input type="checkbox"/> |                          | <input type="checkbox"/> |
| priority-array     | <input type="checkbox"/> |                          |                          |
| relinquish-default | <input type="checkbox"/> | <input type="checkbox"/> |                          |
| cov-increment      | <input type="checkbox"/> | <input type="checkbox"/> | <input type="checkbox"/> |
| time-delay         | <input type="checkbox"/> | <input type="checkbox"/> |                          |
| notification-class | <input type="checkbox"/> | <input type="checkbox"/> |                          |
| high-limit         | <input type="checkbox"/> | <input type="checkbox"/> |                          |
| low-limit          | <input type="checkbox"/> | <input type="checkbox"/> |                          |
| deadband           | <input type="checkbox"/> | <input type="checkbox"/> |                          |
| limit-enable       | <input type="checkbox"/> | <input type="checkbox"/> |                          |
| event-enable       | <input type="checkbox"/> | <input type="checkbox"/> |                          |
| acked-transitions  | <input type="checkbox"/> |                          |                          |
| notify-type        | <input type="checkbox"/> | <input type="checkbox"/> |                          |
| event-time-stamps  | <input type="checkbox"/> |                          |                          |
| profile-name       | <input type="checkbox"/> |                          | <input type="checkbox"/> |



analog-value

Dynamically Creatable

Dynamically Deletable

| Property           | Read                     | Write                    | optional                 |
|--------------------|--------------------------|--------------------------|--------------------------|
| object-identifier  | <input type="checkbox"/> |                          |                          |
| object-name        | <input type="checkbox"/> | <input type="checkbox"/> |                          |
| object-type        | <input type="checkbox"/> |                          |                          |
| present-value      | <input type="checkbox"/> | <input type="checkbox"/> |                          |
| property-list      | <input type="checkbox"/> |                          |                          |
| status-flags       | <input type="checkbox"/> |                          |                          |
| event-state        | <input type="checkbox"/> |                          |                          |
| out-of-service     | <input type="checkbox"/> |                          |                          |
| units              | <input type="checkbox"/> |                          |                          |
| priority-array     | <input type="checkbox"/> |                          |                          |
| relinquish-default | <input type="checkbox"/> | <input type="checkbox"/> |                          |
| time-delay         | <input type="checkbox"/> | <input type="checkbox"/> |                          |
| notification-class | <input type="checkbox"/> | <input type="checkbox"/> |                          |
| high-limit         | <input type="checkbox"/> | <input type="checkbox"/> |                          |
| low-limit          | <input type="checkbox"/> | <input type="checkbox"/> |                          |
| deadband           | <input type="checkbox"/> | <input type="checkbox"/> |                          |
| limit-enable       | <input type="checkbox"/> | <input type="checkbox"/> |                          |
| event-enable       | <input type="checkbox"/> | <input type="checkbox"/> |                          |
| acked-transitions  | <input type="checkbox"/> |                          |                          |
| notify-type        | <input type="checkbox"/> | <input type="checkbox"/> |                          |
| event-time-stamps  | <input type="checkbox"/> |                          |                          |
| cov-increment      | <input type="checkbox"/> | <input type="checkbox"/> | <input type="checkbox"/> |
| profile-name       | <input type="checkbox"/> |                          | <input type="checkbox"/> |

binary-input

Dynamically Creatable

Dynamically Deletable

| Property           | Read                     | Write                    | optional                 |
|--------------------|--------------------------|--------------------------|--------------------------|
| object-identifier  | <input type="checkbox"/> |                          |                          |
| object-name        | <input type="checkbox"/> | <input type="checkbox"/> |                          |
| object-type        | <input type="checkbox"/> |                          |                          |
| present-value      | <input type="checkbox"/> | <input type="checkbox"/> |                          |
| property-list      | <input type="checkbox"/> |                          |                          |
| status-flags       | <input type="checkbox"/> |                          |                          |
| event-state        | <input type="checkbox"/> |                          |                          |
| reliability        | <input type="checkbox"/> | <input type="checkbox"/> | <input type="checkbox"/> |
| out-of-service     | <input type="checkbox"/> | <input type="checkbox"/> |                          |
| polarity           | <input type="checkbox"/> | <input type="checkbox"/> |                          |
| inactive-text      | <input type="checkbox"/> |                          | <input type="checkbox"/> |
| active-text        | <input type="checkbox"/> |                          | <input type="checkbox"/> |
| time-delay         | <input type="checkbox"/> | <input type="checkbox"/> |                          |
| notification-class | <input type="checkbox"/> | <input type="checkbox"/> |                          |
| alarm-value        | <input type="checkbox"/> | <input type="checkbox"/> |                          |
| event-enable       | <input type="checkbox"/> | <input type="checkbox"/> |                          |
| acked-transitions  | <input type="checkbox"/> |                          |                          |
| notify-type        | <input type="checkbox"/> | <input type="checkbox"/> |                          |
| event-time-stamps  | <input type="checkbox"/> |                          |                          |
| profile-name       | <input type="checkbox"/> |                          | <input type="checkbox"/> |

binary-output

Dynamically Creatable

Dynamically Deletable

| Property           | Read                     | Write                    | optional                 |
|--------------------|--------------------------|--------------------------|--------------------------|
| object-identifier  | <input type="checkbox"/> |                          |                          |
| object-name        | <input type="checkbox"/> | <input type="checkbox"/> |                          |
| object-type        | <input type="checkbox"/> |                          |                          |
| present-value      | <input type="checkbox"/> | <input type="checkbox"/> |                          |
| property-list      | <input type="checkbox"/> |                          |                          |
| status-flags       | <input type="checkbox"/> |                          |                          |
| event-state        | <input type="checkbox"/> |                          |                          |
| reliability        | <input type="checkbox"/> | <input type="checkbox"/> | <input type="checkbox"/> |
| out-of-service     | <input type="checkbox"/> | <input type="checkbox"/> |                          |
| polarity           | <input type="checkbox"/> | <input type="checkbox"/> |                          |
| inactive-text      | <input type="checkbox"/> |                          | <input type="checkbox"/> |
| active-text        | <input type="checkbox"/> |                          | <input type="checkbox"/> |
| minimum-off-time   | <input type="checkbox"/> | <input type="checkbox"/> | <input type="checkbox"/> |
| minimum-on-time    | <input type="checkbox"/> | <input type="checkbox"/> | <input type="checkbox"/> |
| priority-array     | <input type="checkbox"/> |                          |                          |
| relinquish-default | <input type="checkbox"/> | <input type="checkbox"/> |                          |
| time-delay         | <input type="checkbox"/> | <input type="checkbox"/> |                          |
| alarm-value        | <input type="checkbox"/> | <input type="checkbox"/> |                          |
| notification-class | <input type="checkbox"/> | <input type="checkbox"/> |                          |
| feedback-value     | <input type="checkbox"/> | <input type="checkbox"/> |                          |
| event-enable       | <input type="checkbox"/> | <input type="checkbox"/> |                          |
| acked-transitions  | <input type="checkbox"/> |                          |                          |
| notify-type        | <input type="checkbox"/> | <input type="checkbox"/> |                          |
| event-time-stamps  | <input type="checkbox"/> |                          |                          |
| profile-name       | <input type="checkbox"/> |                          | <input type="checkbox"/> |

binary-value

Dynamically Creatable

Dynamically Deletable

| Property           | Read                     | Write                    | optional                 |
|--------------------|--------------------------|--------------------------|--------------------------|
| object-identifier  | <input type="checkbox"/> |                          |                          |
| object-name        | <input type="checkbox"/> | <input type="checkbox"/> |                          |
| object-type        | <input type="checkbox"/> |                          |                          |
| present-value      | <input type="checkbox"/> | <input type="checkbox"/> |                          |
| property-list      | <input type="checkbox"/> |                          |                          |
| status-flags       | <input type="checkbox"/> |                          |                          |
| event-state        | <input type="checkbox"/> |                          |                          |
| out-of-service     | <input type="checkbox"/> | <input type="checkbox"/> |                          |
| inactive-text      | <input type="checkbox"/> |                          | <input type="checkbox"/> |
| active-text        | <input type="checkbox"/> |                          | <input type="checkbox"/> |
| minimum-off-time   | <input type="checkbox"/> | <input type="checkbox"/> | <input type="checkbox"/> |
| minimum-on-time    | <input type="checkbox"/> | <input type="checkbox"/> | <input type="checkbox"/> |
| priority-array     | <input type="checkbox"/> |                          |                          |
| relinquish-default | <input type="checkbox"/> | <input type="checkbox"/> |                          |
| time-delay         | <input type="checkbox"/> | <input type="checkbox"/> |                          |
| notification-class | <input type="checkbox"/> | <input type="checkbox"/> |                          |
| alarm-value        | <input type="checkbox"/> | <input type="checkbox"/> |                          |
| event-enable       | <input type="checkbox"/> | <input type="checkbox"/> |                          |
| acked-transitions  | <input type="checkbox"/> |                          |                          |
| notify-type        | <input type="checkbox"/> | <input type="checkbox"/> |                          |
| event-time-stamps  | <input type="checkbox"/> |                          |                          |
| profile-name       | <input type="checkbox"/> |                          | <input type="checkbox"/> |

calendar

Dynamically Creatable

Dynamically Deletable

| Property          | Read                     | Write                    | optional                 |
|-------------------|--------------------------|--------------------------|--------------------------|
| object-identifier | <input type="checkbox"/> |                          |                          |
| object-name       | <input type="checkbox"/> | <input type="checkbox"/> |                          |
| object-type       | <input type="checkbox"/> |                          |                          |
| present-value     | <input type="checkbox"/> |                          |                          |
| property-list     | <input type="checkbox"/> |                          |                          |
| date-list         | <input type="checkbox"/> | <input type="checkbox"/> |                          |
| profile-name      | <input type="checkbox"/> |                          | <input type="checkbox"/> |

device

Dynamically Creatable

Dynamically Deletable

| Property                        | Read                                | Write                               | optional                 |
|---------------------------------|-------------------------------------|-------------------------------------|--------------------------|
| object-identifier               | <input checked="" type="checkbox"/> | <input checked="" type="checkbox"/> |                          |
| object-name                     | <input type="checkbox"/>            | <input type="checkbox"/>            |                          |
| object-type                     | <input type="checkbox"/>            |                                     |                          |
| property-list                   | <input type="checkbox"/>            |                                     |                          |
| system-status                   | <input type="checkbox"/>            |                                     |                          |
| vendor-name                     | <input type="checkbox"/>            |                                     |                          |
| vendor-identifier               | <input type="checkbox"/>            |                                     |                          |
| model-name                      | <input type="checkbox"/>            |                                     |                          |
| firmware-revision               | <input type="checkbox"/>            |                                     |                          |
| application-software-version    | <input type="checkbox"/>            |                                     |                          |
| protocol-version                | <input type="checkbox"/>            |                                     |                          |
| protocol-revision               | <input type="checkbox"/>            |                                     |                          |
| protocol-services-supported     | <input type="checkbox"/>            |                                     |                          |
| protocol-object-types-supported | <input type="checkbox"/>            |                                     |                          |
| object-list                     | <input type="checkbox"/>            |                                     |                          |
| max-apdu-length-accepted        | <input type="checkbox"/>            |                                     |                          |
| segmentation-supported          | <input type="checkbox"/>            |                                     |                          |
| local-time                      | <input type="checkbox"/>            | <input type="checkbox"/>            | <input type="checkbox"/> |
| local-date                      | <input type="checkbox"/>            | <input type="checkbox"/>            | <input type="checkbox"/> |
| utc-offset                      | <input type="checkbox"/>            | <input type="checkbox"/>            | <input type="checkbox"/> |
| daylight-savings-status         | <input type="checkbox"/>            | <input type="checkbox"/>            | <input type="checkbox"/> |
| apdu-timeout                    | <input type="checkbox"/>            | <input type="checkbox"/>            |                          |
| number-of-apdu-retries          | <input type="checkbox"/>            | <input type="checkbox"/>            |                          |
| max-master                      | <input type="checkbox"/>            | <input type="checkbox"/>            | <input type="checkbox"/> |
| max-info-frames                 | <input type="checkbox"/>            | <input type="checkbox"/>            | <input type="checkbox"/> |
| description                     | <input type="checkbox"/>            | <input type="checkbox"/>            | <input type="checkbox"/> |
| location                        | <input type="checkbox"/>            | <input type="checkbox"/>            | <input type="checkbox"/> |
| device-address-binding          | <input type="checkbox"/>            | <input type="checkbox"/>            |                          |
| database-revision               | <input type="checkbox"/>            |                                     |                          |
| active-cov-subscriptions        | <input type="checkbox"/>            |                                     | <input type="checkbox"/> |
| profile-name                    | <input type="checkbox"/>            |                                     | <input type="checkbox"/> |

file

Dynamically Creatable

Dynamically Deletable

| Property           | Read                     | Write                    | optional                 |
|--------------------|--------------------------|--------------------------|--------------------------|
| object-identifier  | <input type="checkbox"/> |                          |                          |
| object-name        | <input type="checkbox"/> |                          |                          |
| object-type        | <input type="checkbox"/> |                          |                          |
| property-list      | <input type="checkbox"/> |                          |                          |
| file-type          | <input type="checkbox"/> |                          |                          |
| file-size          | <input type="checkbox"/> | <input type="checkbox"/> |                          |
| modification-date  | <input type="checkbox"/> |                          |                          |
| archive            | <input type="checkbox"/> |                          |                          |
| read-only          | <input type="checkbox"/> |                          |                          |
| file-access-method | <input type="checkbox"/> |                          |                          |
| profile-name       | <input type="checkbox"/> |                          | <input type="checkbox"/> |

notification-class

Dynamically Creatable

Dynamically Deletable

| Property           | Read                     | Write                    | optional                 |
|--------------------|--------------------------|--------------------------|--------------------------|
| object-identifier  | <input type="checkbox"/> |                          |                          |
| object-name        | <input type="checkbox"/> | <input type="checkbox"/> |                          |
| object-type        | <input type="checkbox"/> |                          |                          |
| property-list      | <input type="checkbox"/> |                          |                          |
| notification-class | <input type="checkbox"/> |                          |                          |
| priority           | <input type="checkbox"/> | <input type="checkbox"/> |                          |
| ack-required       | <input type="checkbox"/> | <input type="checkbox"/> |                          |
| recipient-list     | <input type="checkbox"/> | <input type="checkbox"/> |                          |
| profile-name       | <input type="checkbox"/> |                          | <input type="checkbox"/> |

Schedule

Dynamically Creatable

Dynamically Deletable

| Property                           | Read                     | Write                    | optional                 |
|------------------------------------|--------------------------|--------------------------|--------------------------|
| object-identifier                  | <input type="checkbox"/> |                          |                          |
| object-name                        | <input type="checkbox"/> | <input type="checkbox"/> |                          |
| object-type                        | <input type="checkbox"/> |                          |                          |
| present-value                      | <input type="checkbox"/> | <input type="checkbox"/> |                          |
| property-list                      | <input type="checkbox"/> |                          |                          |
| effective-period                   | <input type="checkbox"/> | <input type="checkbox"/> |                          |
| weekly-schedule                    | <input type="checkbox"/> | <input type="checkbox"/> |                          |
| exception-schedule                 | <input type="checkbox"/> | <input type="checkbox"/> |                          |
| schedule-default                   | <input type="checkbox"/> | <input type="checkbox"/> |                          |
| list-of-object-property-references | <input type="checkbox"/> |                          |                          |
| priority-for-writing               | <input type="checkbox"/> |                          |                          |
| status-flags                       | <input type="checkbox"/> |                          |                          |
| reliability                        | <input type="checkbox"/> |                          |                          |
| out-of-service                     | <input type="checkbox"/> | <input type="checkbox"/> |                          |
| profile-name                       | <input type="checkbox"/> |                          | <input type="checkbox"/> |



trend-log

Dynamically Creatable

Dynamically Deletable

| Property                   | Read                     | Write                    | optional                 |
|----------------------------|--------------------------|--------------------------|--------------------------|
| object-identifier          | <input type="checkbox"/> |                          |                          |
| object-name                | <input type="checkbox"/> | <input type="checkbox"/> |                          |
| object-type                | <input type="checkbox"/> |                          |                          |
| log-enable                 | <input type="checkbox"/> | <input type="checkbox"/> |                          |
| start-time                 | <input type="checkbox"/> | <input type="checkbox"/> | <input type="checkbox"/> |
| stop-time                  | <input type="checkbox"/> | <input type="checkbox"/> | <input type="checkbox"/> |
| log-device-object-property | <input type="checkbox"/> |                          | <input type="checkbox"/> |
| log-interval               | <input type="checkbox"/> | <input type="checkbox"/> | <input type="checkbox"/> |
| stop-when-full             | <input type="checkbox"/> | <input type="checkbox"/> |                          |
| buffer-size                | <input type="checkbox"/> |                          |                          |
| record-count               | <input type="checkbox"/> | <input type="checkbox"/> |                          |
| total-record-count         | <input type="checkbox"/> |                          |                          |
| event-state                | <input type="checkbox"/> |                          |                          |
| logging-type               | <input type="checkbox"/> |                          |                          |
| status-flags               | <input type="checkbox"/> |                          |                          |
| event-enable               | <input type="checkbox"/> | <input type="checkbox"/> | <input type="checkbox"/> |
| notification-class         | <input type="checkbox"/> | <input type="checkbox"/> | <input type="checkbox"/> |
| acked-transitions          | <input type="checkbox"/> |                          | <input type="checkbox"/> |
| notify-type                | <input type="checkbox"/> | <input type="checkbox"/> | <input type="checkbox"/> |
| cov-increment              | <input type="checkbox"/> |                          | <input type="checkbox"/> |
| event-time-stamps          | <input type="checkbox"/> |                          | <input type="checkbox"/> |
| notification-threshold     | <input type="checkbox"/> | <input type="checkbox"/> | <input type="checkbox"/> |
| last-notify-record         | <input type="checkbox"/> |                          | <input type="checkbox"/> |
| records-since-notification | <input type="checkbox"/> |                          | <input type="checkbox"/> |
| profile-name               | <input type="checkbox"/> |                          | <input type="checkbox"/> |

Data Link Layer Options:

- BACnet IP, (Annex J)
- BACnet IP, (Annex J), Foreign Device
- ISO 8802-3, Ethernet (Clause 7)
- ATA 878.1, 2.5 Mb. ARCNET (Clause 8)
- ATA 878.1, EIA-485 ARCNET (Clause 8), baud rate(s) : N/A
- MS/TP master (Clause 9)**, baud rate(s): **9600, 19200, 38400, 57600, 76800, 115200\***
  - MS/TP slave (Clause 9), baud rate(s): N/A
  - Point-To-Point, EIA 232 (Clause 10), baud rate(s): N/A
  - Point-To-Point, modem, (Clause 10), baud rate(s): N/A
  - LonTalk, (Clause 11), medium: N/A
  - Other: N/A

*\*Note: 115200 baud is not supported on CBM models*

Device Address Binding:

Is static device binding supported?  Yes  No

(This is currently necessary for two-way communication with MS/TP slaves and certain other devices.)

Networking Options:

Router, Clause 6 - IP, MS/TP, Ethernet

Annex H, BACnet Tunneling Router over IP

BACnet/IP Broadcast Management Device (BBMD)

Does the BBMD support registrations by Foreign Devices?  Yes  No

Character Sets Supported:

Indicating support for multiple character sets does not imply that they can all be supported simultaneously.

ANSI X3.4.

IBM™/Microsoft™ DBCS

ISO 8859-1

ISO 10646 (UCS-2)

ISO 10646 (UCS-4)

JIS C 6226

If this product is a communication gateway, describe the types of non-BACnet equipment/networks(s) that the gateway supports:

N/A

## APPENDIX: PROPRIETARY BACNET PROPERTIES

The following proprietary properties are available in Cylon BACnet Field Controllers:

On CBT only:

### Object Class: Device

| Property Number | Property          | Description   | Read/Write | Valid values  | Datatype         |
|-----------------|-------------------|---|------------|---|------------------|
| 50771           | (FS) Flash Status | This variable indicates if the CBT is currently backing up its data to flash. | Read Only  | <ul style="list-style-type: none"> <li>•“Flash is idle”</li> <li>•“Points flash in process”</li> <li>•“Full strategy flash in process”</li> </ul> | Character String |

On both CBM and BT controllers:

### Object Class: Analog Values

| Property Number | Property                                     | Description  | Read/Write | Valid values | Datatype   |
|-----------------|--|--|------------|--------------|------------|
| 49492           | (AT) Auto-Clear Time to Live                 | The Auto-Clear Function is an option whereby a temporary override value – i.e. a value written via the front end at a specified priority - has a certain “time to live” before the value at that priority is automatically reset to null. This property sets the time after which the override value will be set to null. If set to 0, this functionality is inactive                              | R/W        | Not Bounded  | Unsigned   |
| 49488           | (AP) Auto-Clear Priority                     | This is the priority array index of the value that has a time to live when using the auto-clear functionality.   | R/W        | 1-16         | Enumerated |
| 49475           | (AC) Auto-Clear Countdown                    | This property states the current number of seconds until the override is cleared.  | Read Only  |              | Unsigned   |
| 54096           | (SP) Save Priority Array Data Across Reboots | When set this will make the priority array save itself to flash any time there is a change to it. It is left off (set to 0) by default as most strategies will consider priority array entries to be transient data. In the event that someone has chosen to pack data in the array that won't re-establish itself naturally after a boot, then this switch can be turned on to force flash saves. | R/W        | 0/1          | Boolean    |

### Object Class: Binary Values

| Property Number | Property                                     | Description  | Read/Write | Valid values | Datatype   |
|-----------------|--|--|------------|--------------|------------|
| 49492           | (AT) Auto-Clear Time to Live                 | The Auto-Clear Function is an option whereby a temporary override value – i.e. a value written via the front end at a specified priority - has a certain “time to live” before the value at that priority is automatically reset to null. This property sets the time after which the override value will be set to null.  | R/W        | Not Bounded  | Unsigned   |
| 49488           | (AP) Auto-Clear Priority                     | This is the priority array index of the value that has a time to live when using the auto-clear functionality.   | R/W        | 1-5, 6-16    | Enumerated |
| 49475           | (AC) Auto-Clear Countdown                    | This property states the current number of seconds until the override is cleared.  | Read Only  |              | Unsigned   |
| 54096           | (SP) Save Priority Array Data Across Reboots | When set this will make the priority array save itself to flash any time there is a change to it. It is left off (set to 0) by default as most <b>Strategies</b> will consider priority array entries to be transient data. In the event that someone has chosen to pack data in the array that won't re-establish itself naturally after a boot, then this switch can be turned on to force <b>flash</b> saves. | R/W        | 0/1          | Boolean    |

**Object Class: Calendars**

| Property Number | Property          | Description  | Read/Write | Valid values | Datatype |
|-----------------|-------------------|--|------------|--------------|----------|
| 50004           | (CT) Current Time | These are provided for the SI's convenience. It is the same data as the actual date and time values in the Device object but being mirrored in the schedules and calendars allows them to more easily troubleshoot their scheduling. | Read Only  |              | Time     |
| 49988           | (CD) Current Date | These are provided for the SI's convenience. It is the same data as the actual date and time values in the Device object but being mirrored in the schedules and calendars allows them to more easily troubleshoot their scheduling. | Read Only  |              | Date     |

**Object Class: Device**

| Property Number | Property                                     | Description   | Read/Write | Valid values                           | Datatype         |
|-----------------|--|---|------------|--|------------------|
| 54094           | (SN) Serial Number                           | This text string is the serial number for the controller as set in the factory.   | Read Only  |  | Character String |
| 54089           | (SI) Strategy Index Number                   | There is a new object in the <b>Cylon Engineering Center</b> called "Strategy ID." When added to a <b>Strategy</b> , that number will be displayed in this field, allowing the <b>OWS</b> to load pre-configured templates used for that particular <b>Strategy</b> . | Read Only  |  |                  |
| 51524           | (ID) Unit Number (MSTP)                      | This is the MSTP address of the Device. Writing to it will cause the device to immediately drop out of the token loop and reappear in the new address specified.  | R/W        | 0-127                                  | Unsigned         |
| 54606           | (UN) Unitron Number                          | This is the Unitron ID. It is advised that it be set to the same as the BACnet ID, but if required it can be written to freely via this property.   | R/W        | 0-127                                  | Unsigned         |
| 54612           | (UT) System Up-Time (Seconds)                | This is the number of seconds since the last boot.  | Read Only  |  | Unsigned         |
| 54081           | (SA) Save All Data to Flash                  | On the <b>CBT</b> this will force all data to be saved to flash. On the battery backed <b>CBM</b> it is actually of no value.   | R/W        | 1                                      | Unsigned         |
| 53843           | (RS) Reset/Reboot the Controller             | This will cause the controller to reboot after a 300ms delay.   | R/W        | 1                                      | Unsigned         |
| 49491           | (AS) Auto-Delete Schedule & Calendar Entries | When set, any date-specific entries will be deleted after the end of the day on which they are viable. This is intended to clear out the scheduling data for non-recurring events.  | R/W        | 0/1                                    | Boolean          |
| 50754           | (FB) Feedback Text                           | This is the <b>Engineering Center</b> feedback Text field. When downloading a <b>Strategy</b> , any errors in the <b>Strategy</b> will be catalogued in this text variable. Writing to it clears it out, as does starting a new <b>Strategy</b> download.             | R/W        | Any write will clear out this variable | Character String |

**Object Class: Notification**

| Property Number | Property                 | Description   | Read/Write | Valid values | Datatype |
|-----------------|--------------------------|---|------------|--------------|----------|
| 49457           | (A1) Recipient 1 Active? | Cylon supports up to 5 different recipients per <b>notification class</b> object. These read-only feedback variables aid in debugging any <b>Alarm</b> issues by indicating if any recipients are currently marked as active. | Read Only  |              | Boolean  |
| 49458           | (A2) Recipient 2 Active? |   |            |              |          |
| 49459           | (A3) Recipient 3 Active? |   |            |              |          |
| 49460           | (A4) Recipient 4 Active? |   |            |              |          |
| 49461           | (A5) Recipient 5 Active? |   |            |              |          |

**Object Class: Manufacturer Debug**

| Property Number | Property                                 | Description  | Read/Write | Valid values | Datatype |
|-----------------|--|--|------------|--------------|----------|
| 49748           | (BT) MSTP Token Round Trip in Seconds    | This variable indicates the average speed of the BACnet network. It is used for determining the relative load of the BACnet network. | Read Only  |              | Real     |
| 49747           | (BS) Strategy Blocks Currently Servicing | This Unitron variable indicates the number of blocks currently servicing in the strategy   | Read Only  |              | Integer  |
| 54100           | (ST) Strategy Service Time in Seconds    | This Unitron variable indicates the number of blocks currently servicing in the strategy   | Read Only  |              | Real     |

**Object Class: Schedules**

| Property Number | Property                                 | Description  | Read/Write | Valid values   | Datatype   |
|-----------------|--|--|------------|--|--|
| 50260           | (DT) Schedule's Default Data Type        | Writing to this variable using any of the datatypes listed to the right will cause the schedule default (and thus the schedule as a whole) to change to that datatype.   | R/W        | Any  | <ul style="list-style-type: none"> <li>• Boolean</li> <li>• Unsigned</li> <li>• Integer</li> <li>• Real</li> <li>• Enumerated</li> <li>• Date</li> <li>• Time</li> <li>• ObjectID</li> </ul> |
| 54100           | (ST) Whole Seconds Until Next Transition | This feedback variable is used for Schedule troubleshooting.   | Read Only  |  | Integer  |
| 52564           | (MT) Whole Minutes Until Next Transition | This feedback variable is used for Schedule troubleshooting.   | Read Only  |  | Integer  |
| 51284           | (HT) Whole Hours Until Next Transition   | This feedback variable is used for Schedule troubleshooting.   | Read Only  |  | Integer  |
| 52819           | (NS) Next Transition State               | The next time the schedule changes, this is the value that will become the present value.  |            |  | Varies - based on Schedule Datatype  |
| 50004           | (CT) Current Time                        | These are provided for the SI's convenience. It is the same data as the actual date and time values in the Device object but being mirrored in the schedules and calendars allows them to more easily troubleshoot their scheduling. | Read Only  |  | Time   |
| 49988           | (CD) Current Date                        | These are provided for the SI's convenience. It is the same data as the actual date and time values in the Device object but being mirrored in the schedules and calendars allows them to more easily troubleshoot their scheduling. | Read Only  |  | Date   |
| 50754           | (FB) Feedback Text                       | This provides information regarding the driving force behind the current present value. Messages are tailored by datatype to include the present value as well making this value suitable for OWS mirroring.                         | Read Only  | <ul style="list-style-type: none"> <li>• Default</li> <li>• Daily</li> <li>• Exception</li> <li>• Eff. Period</li> <li>• Stat Exception</li> <li>• Out Of Service</li> <li>* All of the above are also followed by data</li> </ul> | Character String   |

**Object Class: Unitron Schedules**

| Property Number | Property          | Description   | Read/Write | Valid values         | Datatype  |
|-----------------|-------------------|---|------------|----------------------|-----------|
| 49476           | (AD) Active Days  | This feedback variable indicates on which days of the week the schedule object is active. | Read Only  | Bit 0 = Monday       | Bitstring |
| 54065           | (S1) Start Time 1 | Occupied Time 1   | R/W        | Any valid time value | Time      |
| 50481           | (E1) End Time 1   | Unoccupied Time 1   | R/W        | Any valid time value | Time      |
| 54066           | (S2) Start Time 2 | Occupied Time 2   | R/W        | Any valid time value | Time      |
| 50482           | (E2) End Time 2   | Unoccupied Time 2   | R/W        | Any valid time value | Time      |



---

ABB CYLON CONTROLS

Clonsaugh Business &  
Technology Park  
Clonsaugh  
Dublin 17  
Ireland

Tel.: +353 1 245 0500  
Fax: +353 1 245 0501  
Email: [info@cylon.com](mailto:info@cylon.com)

---

ABB CYLON CONTROLS

ONE TECHNOLOGY LANE  
EXPORT,  
PA 15632

Tel.: +1 724 733-2000  
Fax: +1 724 327-6124